

Wire

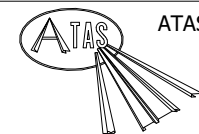

Threaded Rod

Direct Attachment

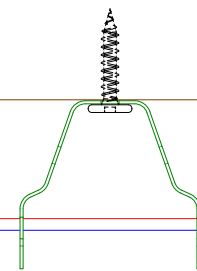

ATAS INTERNATIONAL, INC  
 Allentown PA  
 610-395-8445  
 Mesa AZ  
 480-558-7210

TITLE  
 Linear Ceiling Carrier Installation Detail

REV. NO.	DATE	DESCRIPTION OF REVISION	BY	APP	DWG. NO.	DR	KRK	DATE	5/29/2018
						APP		DATE	
					MATERIAL	SH. SIZE	B	SCALE	X:X

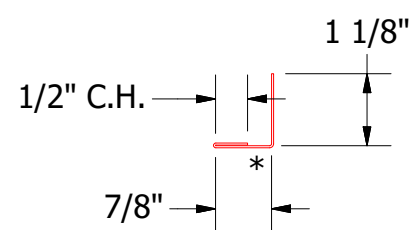
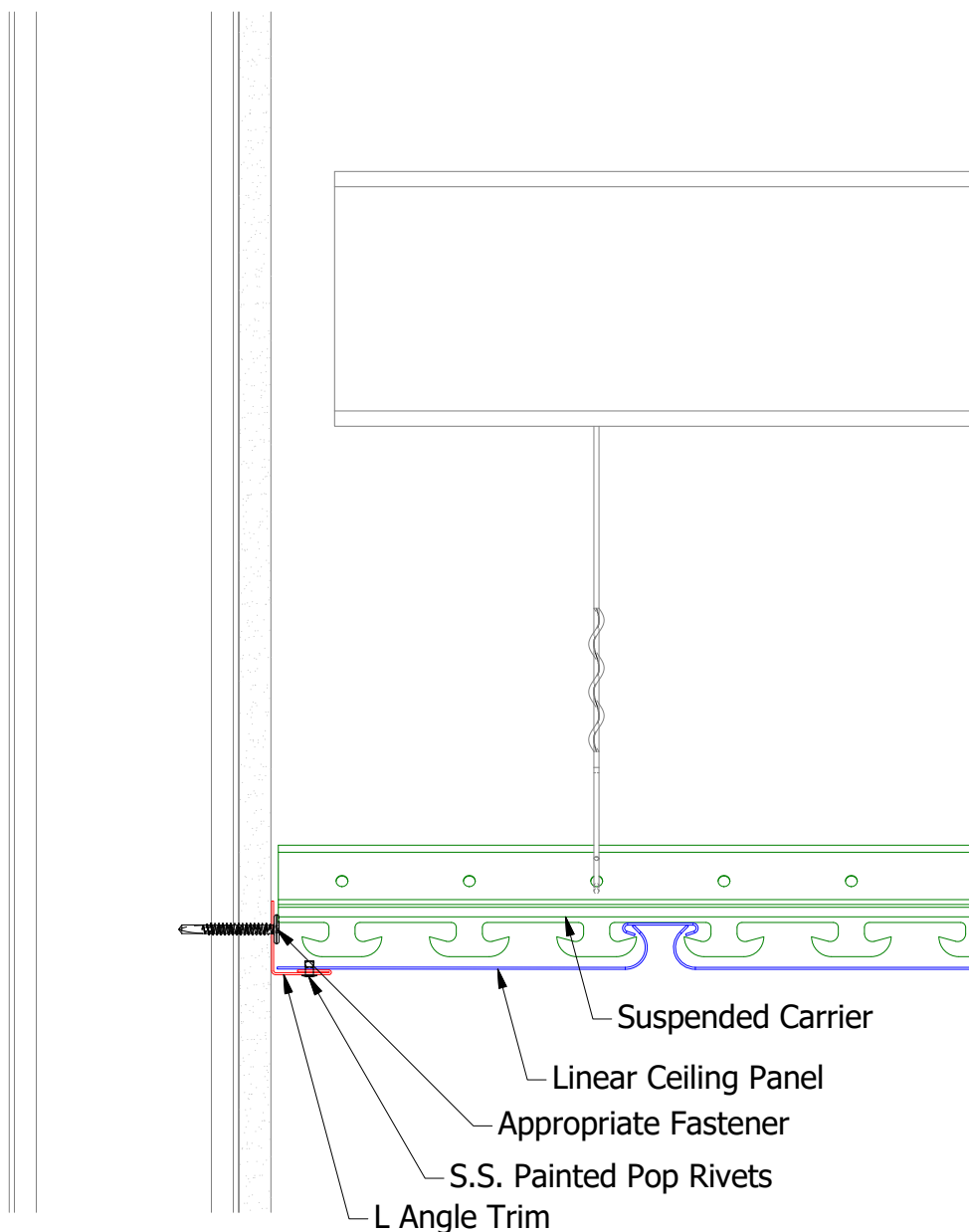
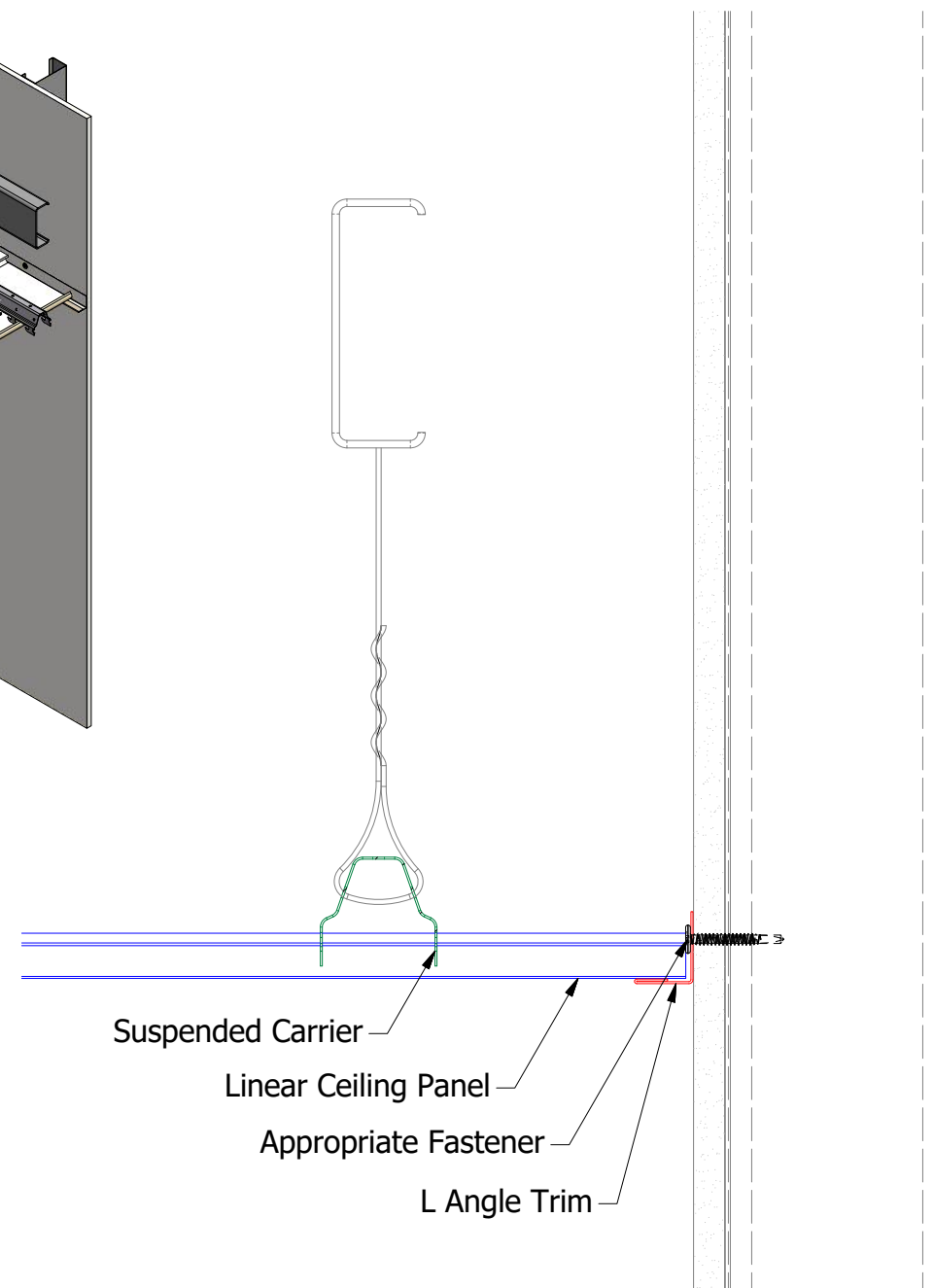
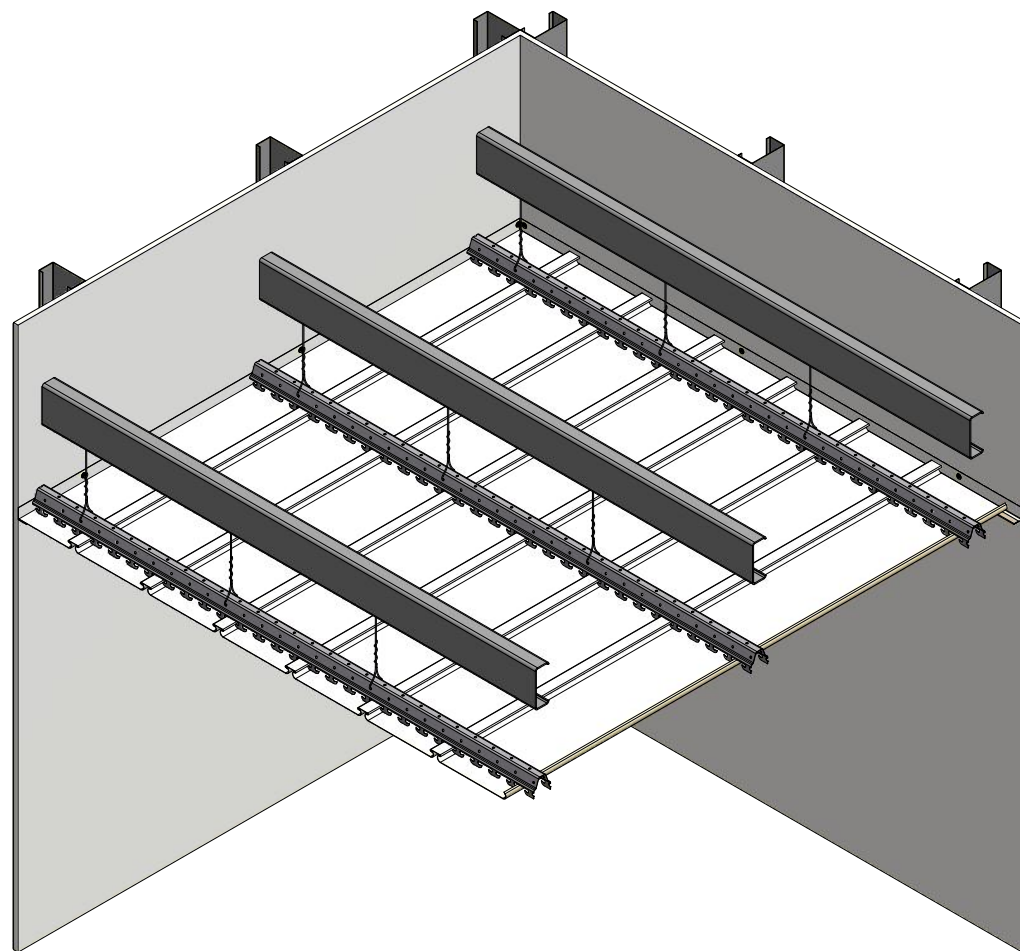

UNL078 - L Angle Trim

Note: \* denotes color side.

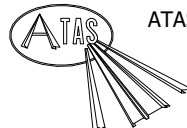
 <b>ATAS INTERNATIONAL, INC</b> Allentown PA 610-395-8445 Mesa AZ 480-558-7210		<b>TITLE</b> Linear Ceiling Endwall Detail	
		DWG. NO.	DR KRK
REV. NO.    DATE    DESCRIPTION OF REVISION    BY    APP		APP	DATE
MATERIAL		SH. SIZE B	SCALE X:X

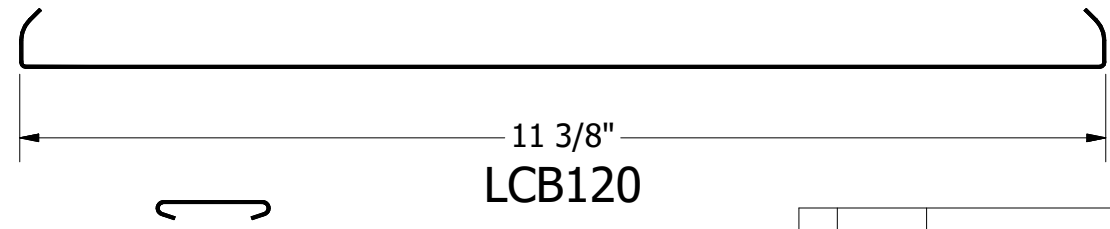
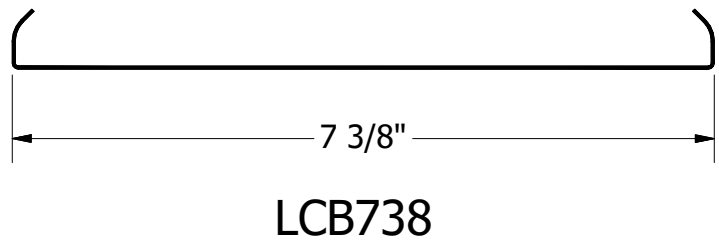
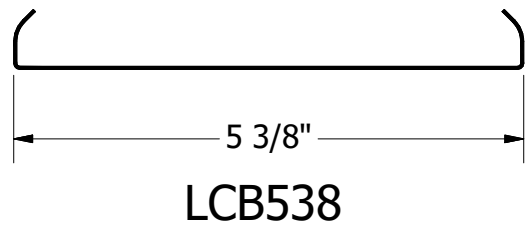
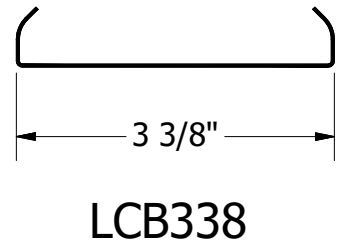
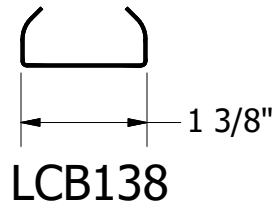
Recessed Filler Strip

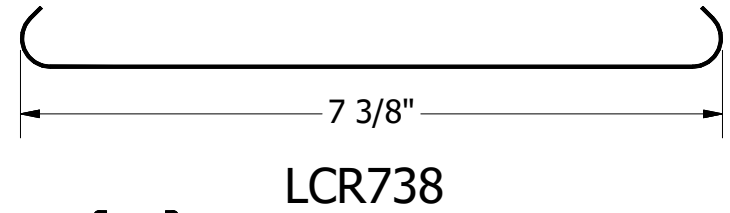
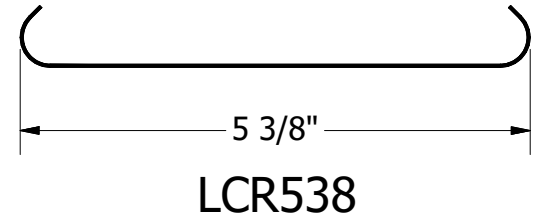
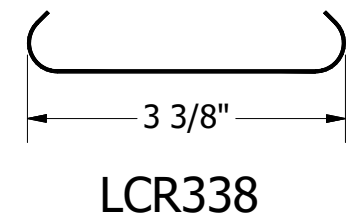

Flush Filler Strip

Recessed Filler Strip

ATAS INTERNATIONAL, INC  
 Allentown PA  
 610-395-8445  
 Mesa AZ  
 480-558-7210

TITLE Linear Ceiling Panel Profile Detail

02	3/19/2025	Added LCB138 and LCB120	KRK	DWG. NO.	DR	KRK	DATE	5/29/2018
01	12/19/2022	Added LCB538 and LCR538	KRK	MATERIAL	APP		DATE	
REV. NO.	DATE	DESCRIPTION OF REVISION	BY	APP	SH. SIZE	A	SCALE	X:X

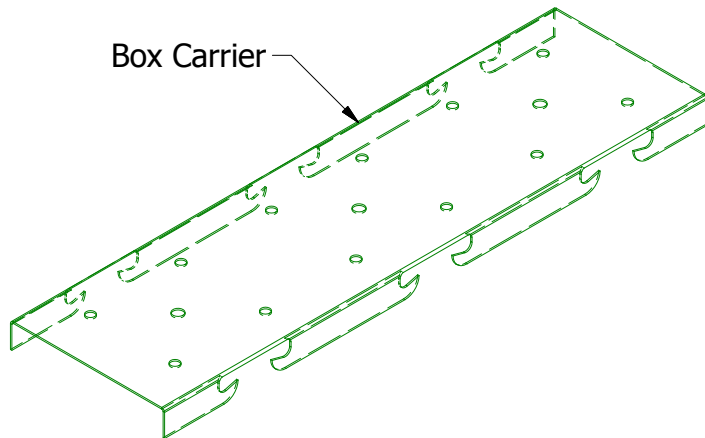
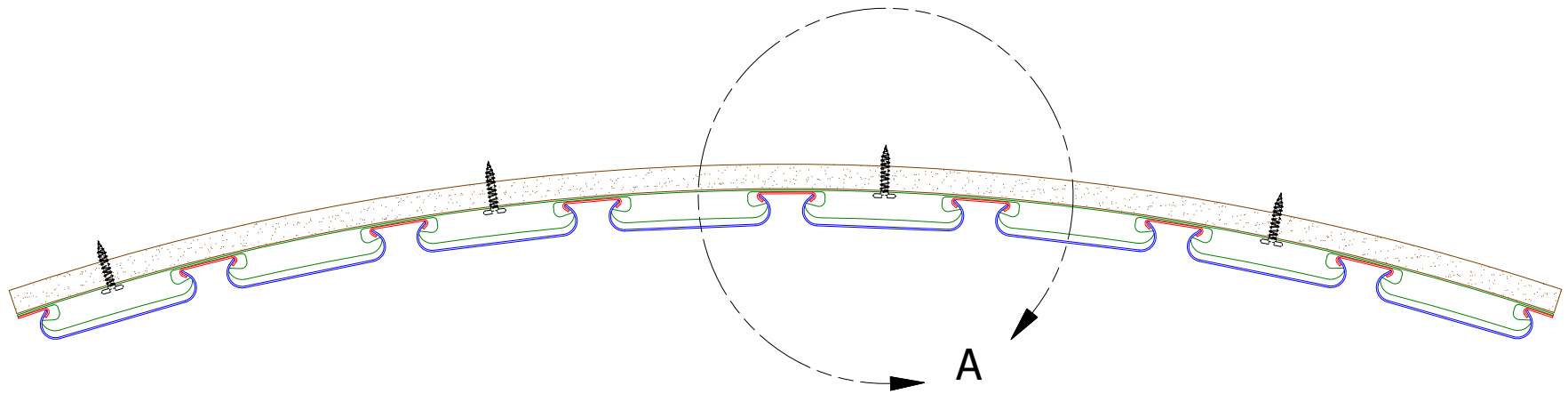

Box Carrier

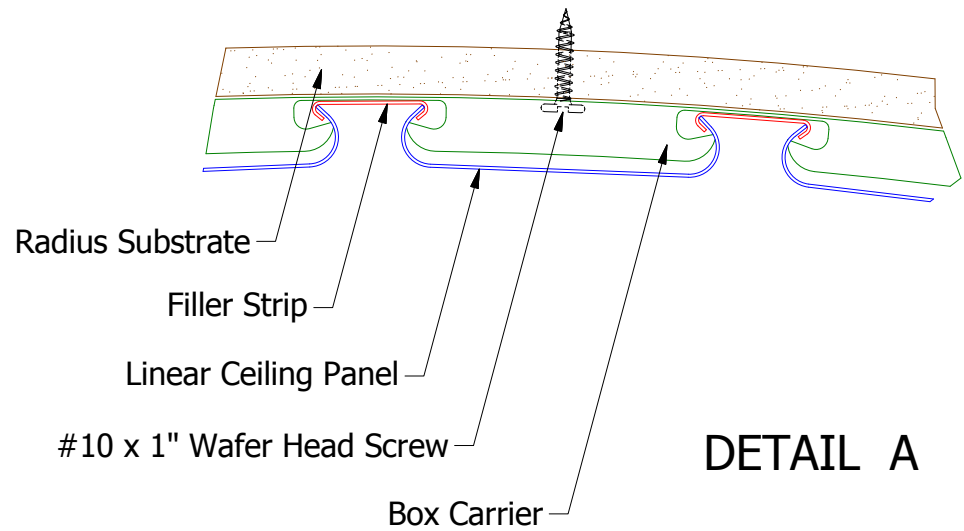

Radius Substrate

Filler Strip

Linear Ceiling Panel

#10 x 1" Wafer Head Screw

Box Carrier

**DETAIL A**

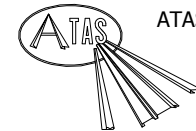

ATAS INTERNATIONAL, INC  
 Allentown PA  
 610-395-8445  
 Mesa AZ  
 480-558-7210

TITLE **Linear Ceiling Radius Detail**

REV. NO.	DATE	DESCRIPTION OF REVISION	BY	APP	DWG. NO.	DR KRK	DATE 2/20/2018
					MATERIAL	APP	DATE
						SH. SIZE <b>A</b>	SCALE <b>X:X</b>

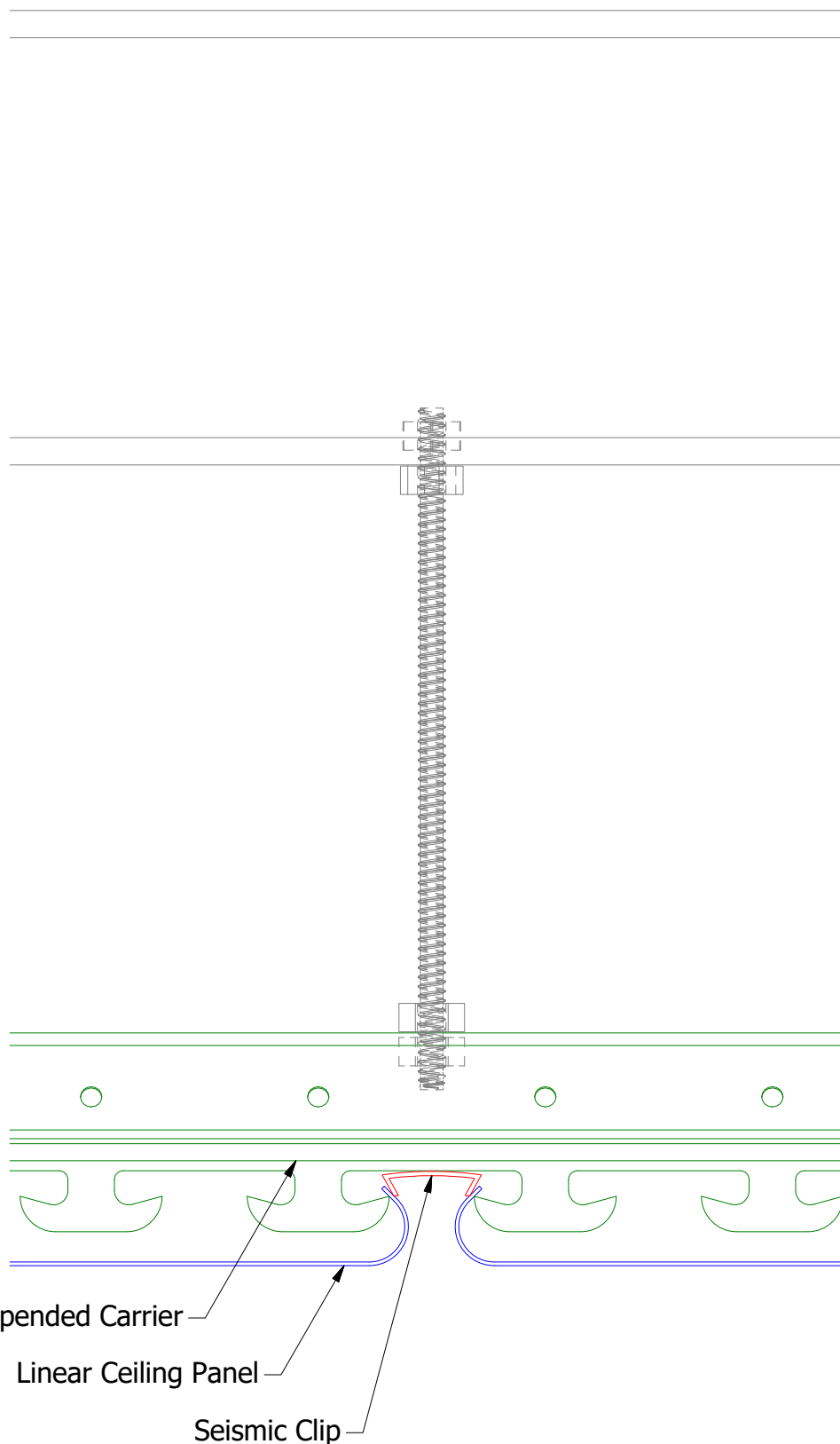

Suspended Carrier  
 Linear Ceiling Panel  
 Seismic Clip

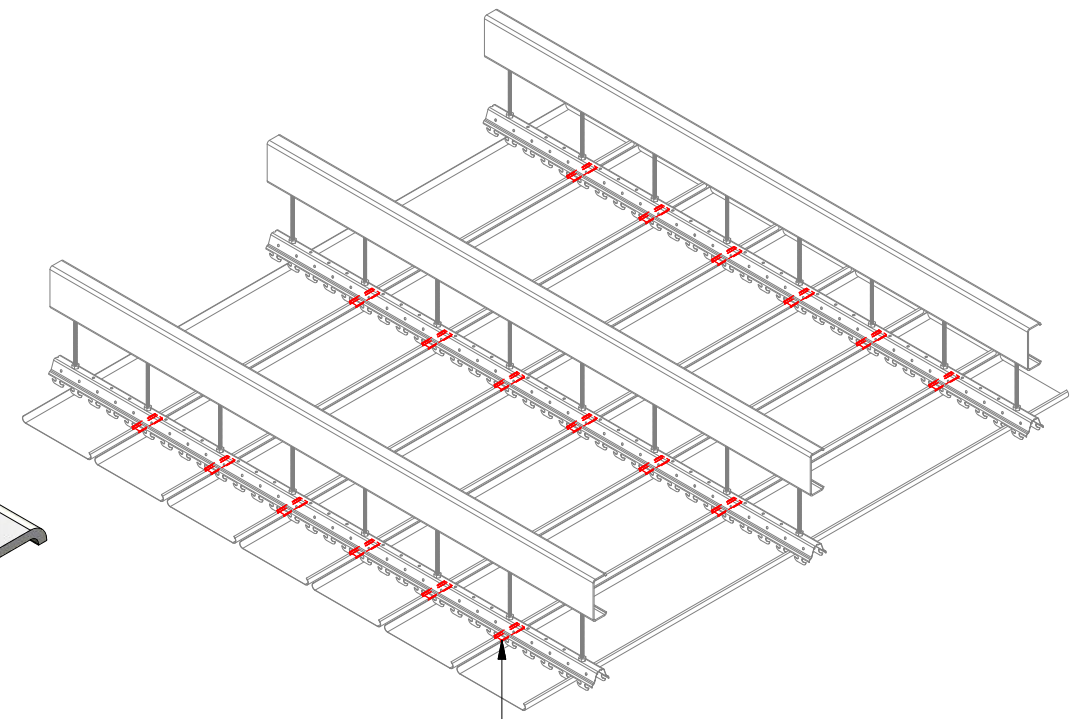
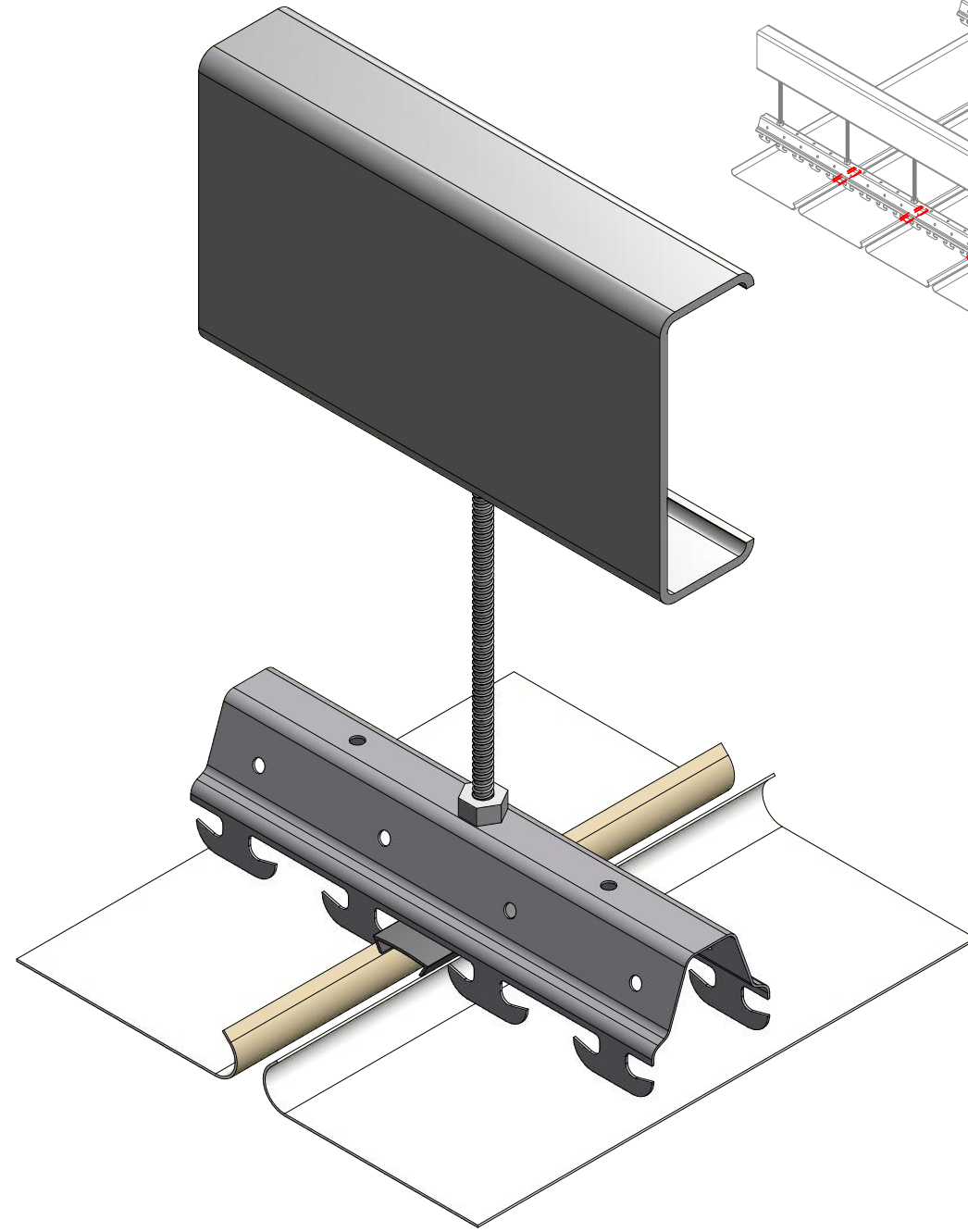

Seismic Clip at every point of contact between Panel and Carrier.

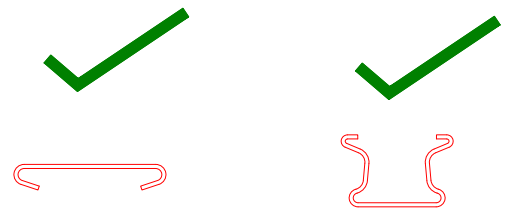

**Note:** Seismic Clip can be used with both Recessed Filler Strip and Flush Filler Strip



**ATAS INTERNATIONAL, INC**  
 Allentown PA  
 610-395-8445  
 Mesa AZ  
 480-558-7210

TITLE				Linear Ceiling Seismic Clip Detail			
DWG. NO.		DR	KRK	DATE	5/30/2018	APP	
REV. NO.	DATE	DESCRIPTION OF REVISION	BY	APP	SH. SIZE	B	SCALE X:X
01	2/9/2024	Updated Carrier	KRK				

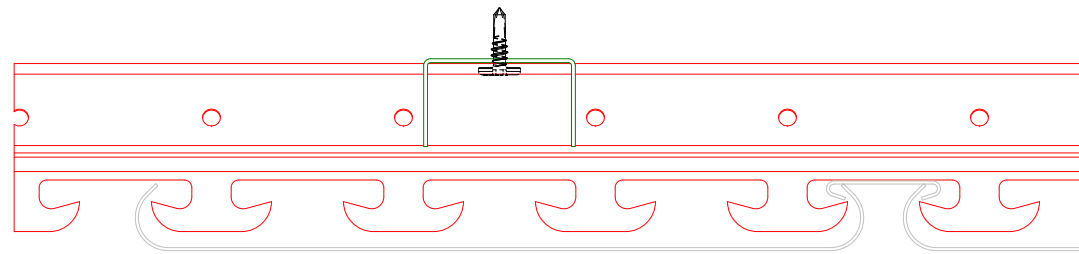

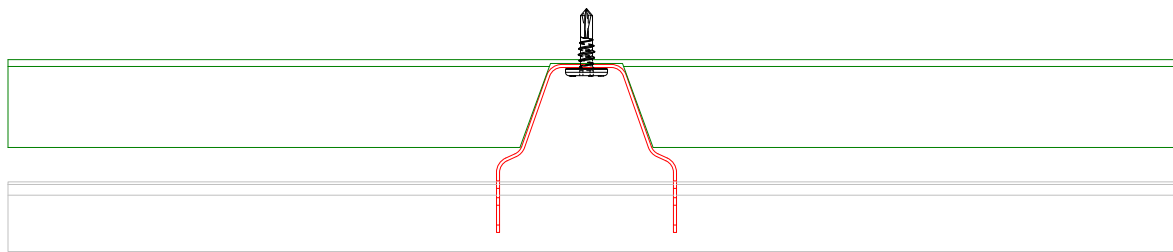

SECTION A-A



SECTION B-B

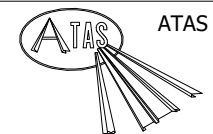
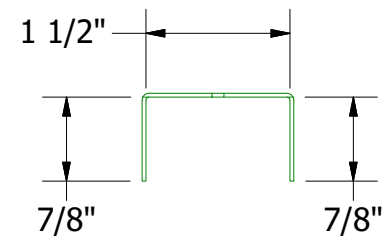
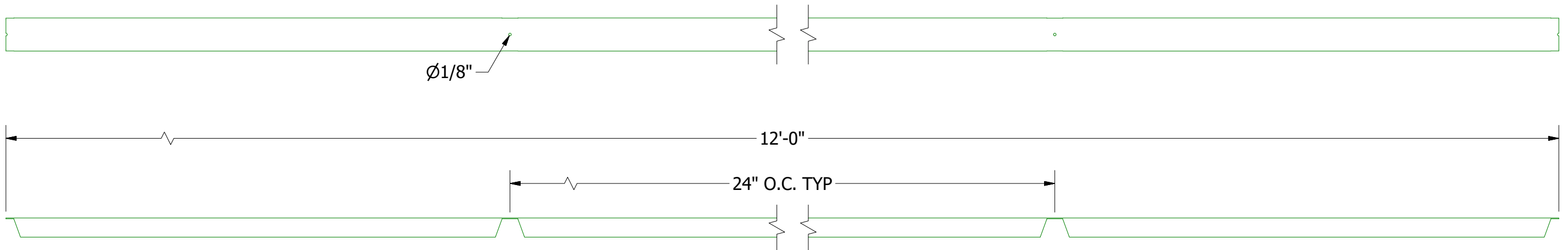
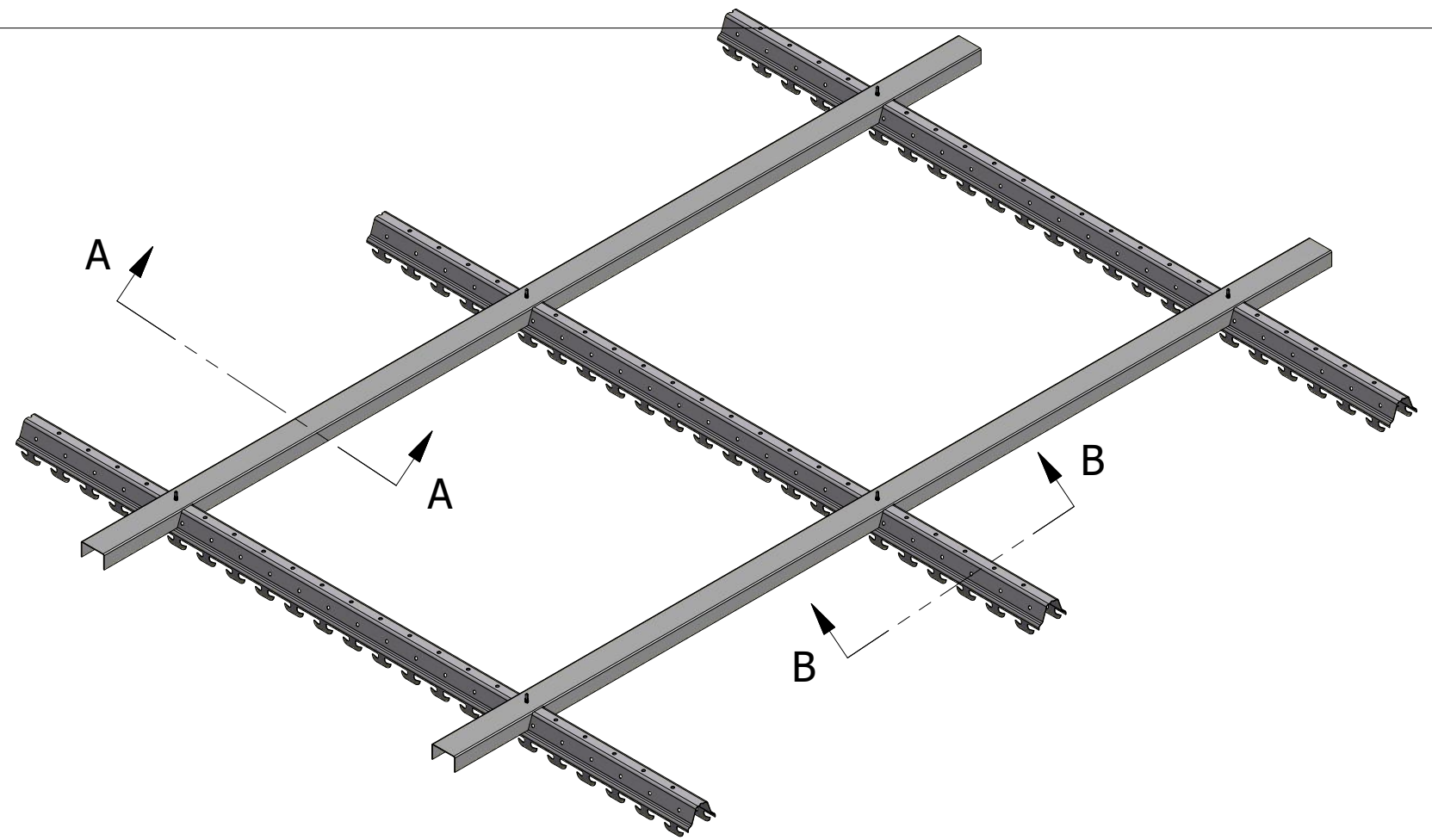

ATAS INTERNATIONAL, INC  
 Allentown PA  
 610-395-8445  
 Mesa AZ  
 480-558-7210

TITLE  
**Linear Ceiling Cross Carrier Spacer Detail**

					DWG. NO.	DR	KRK	DATE	6/8/2023
01	2/13/2024	Updated Carrier	KRK	APP	MATERIAL	SH. SIZE	B	SCALE	X:X
REV. NO.	DATE	DESCRIPTION OF REVISION	BY	APP					