

Wire

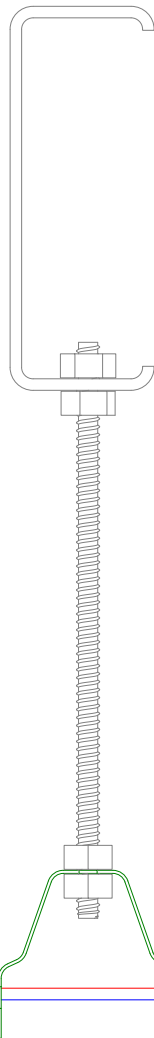

Threaded Rod

Direct Attachment

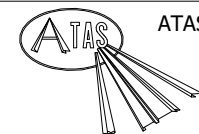
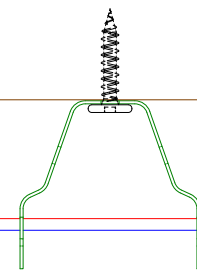

ATAS INTERNATIONAL, INC
 Allentown PA
 610-395-8445
 Mesa AZ
 480-558-7210

TITLE
 Linear Ceiling Carrier Installation Detail

REV. NO.	DATE	DESCRIPTION OF REVISION	BY	APP	DWG. NO.	DR	KRK	DATE	5/29/2018
						APP		DATE	
					MATERIAL	SH. SIZE	B	SCALE	X:X

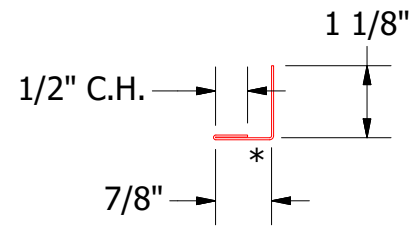
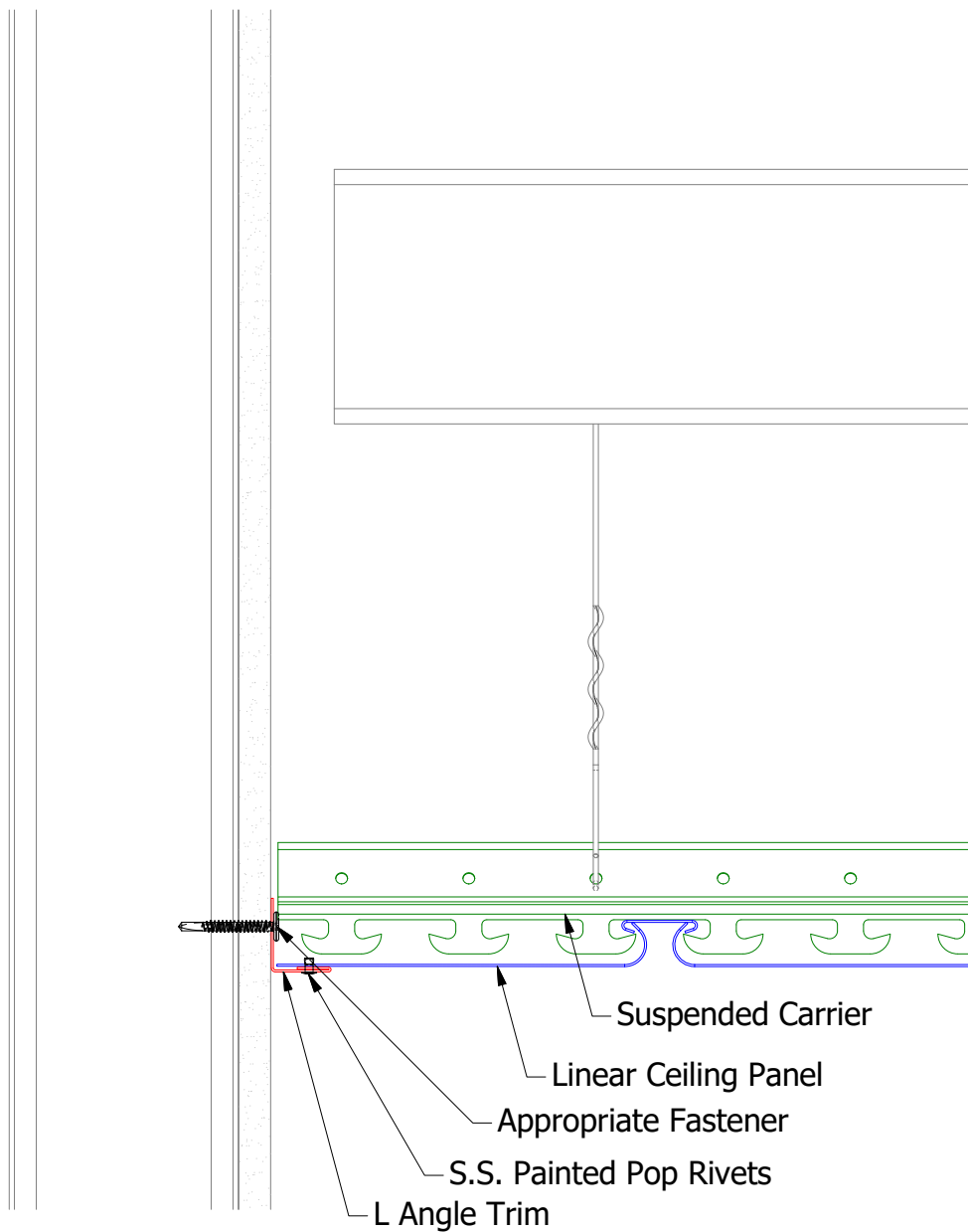
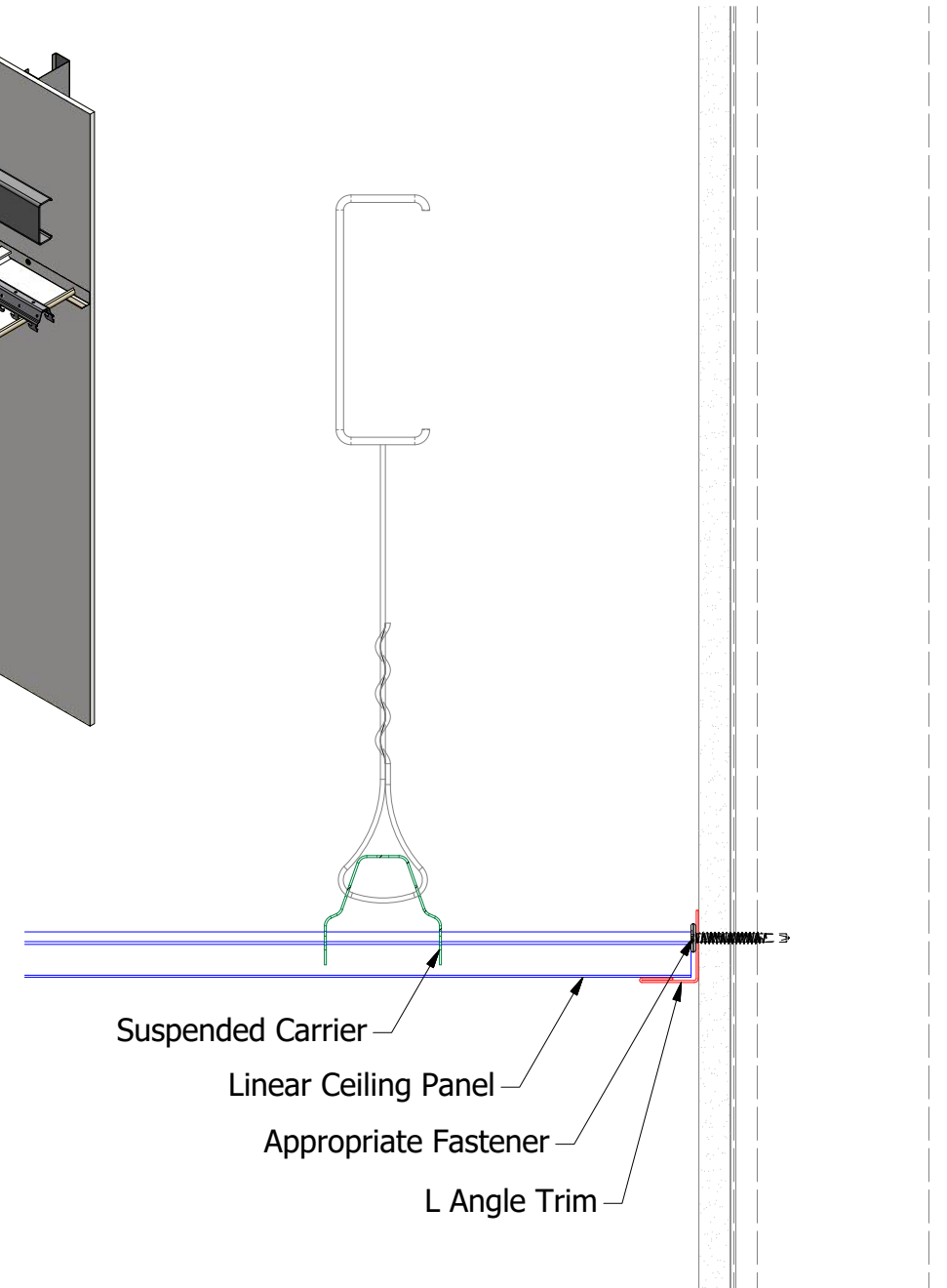
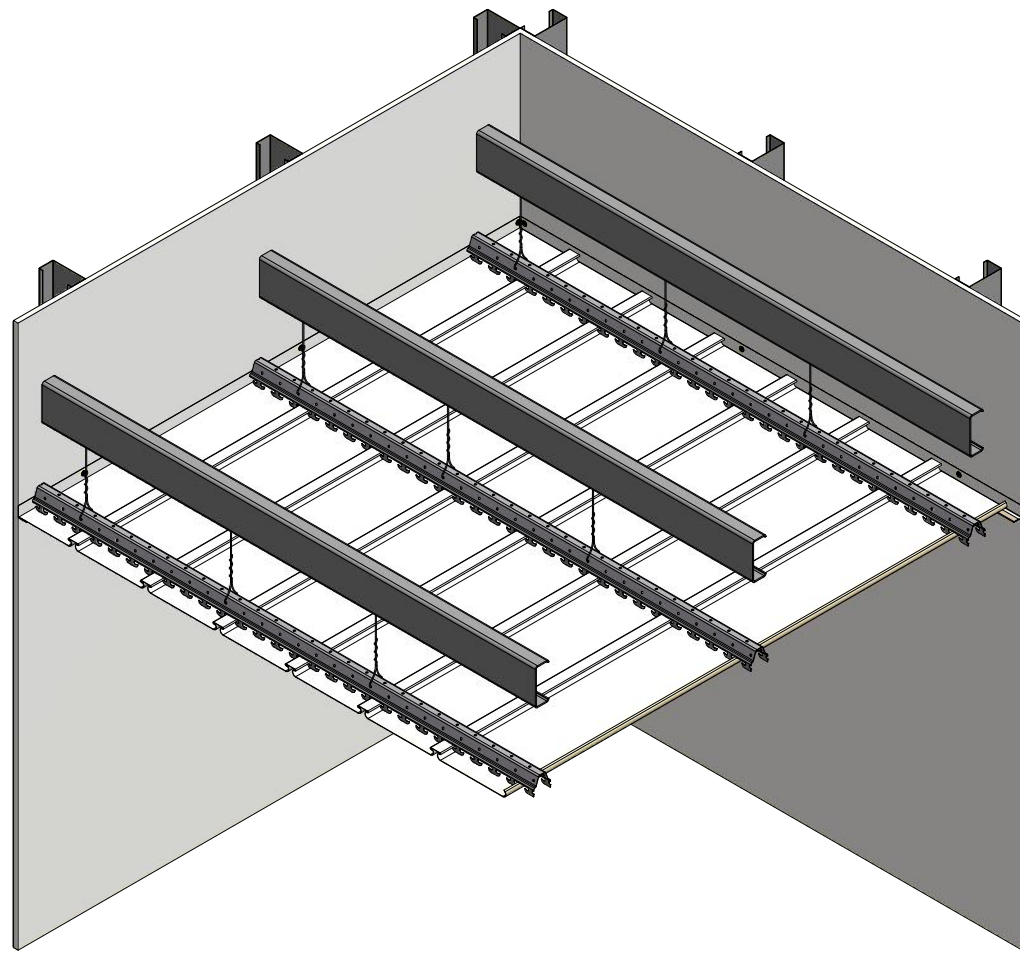

UNL078 - L Angle Trim

Note: * denotes color side.



ATAS INTERNATIONAL, INC
 Allentown PA
 610-395-8445
 Mesa AZ
 480-558-7210

REV. NO.		DATE	DESCRIPTION OF REVISION	BY	APP
DWG. NO.		DR	KRK	DATE	5/25/2023
MATERIAL		APP		DATE	
SH. SIZE		B	SCALE	X:X	

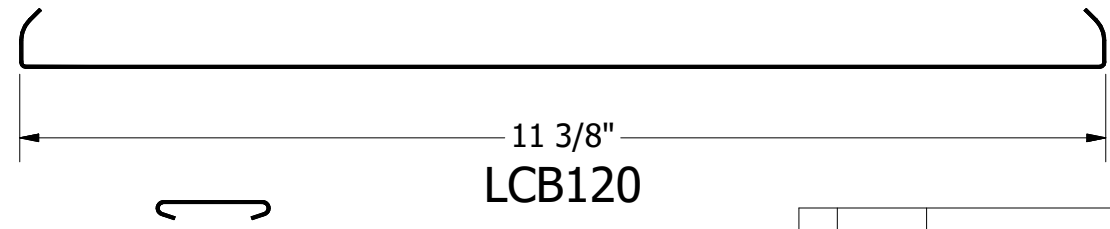
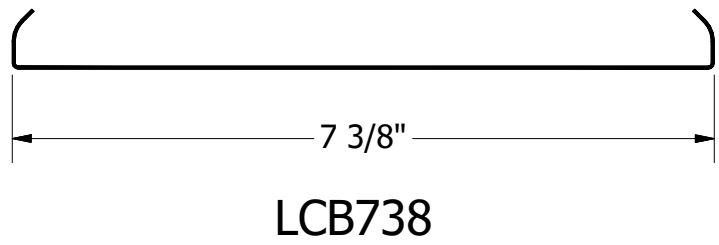
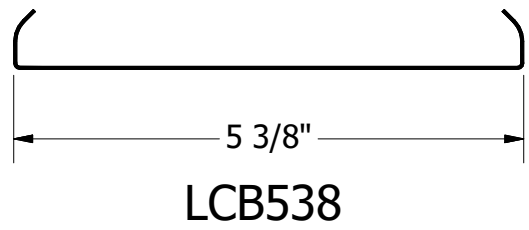
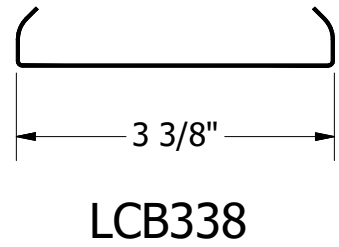
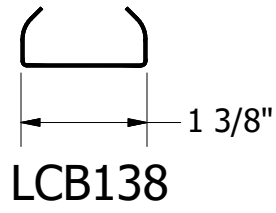
TITLE **Linear Ceiling Endwall Detail**

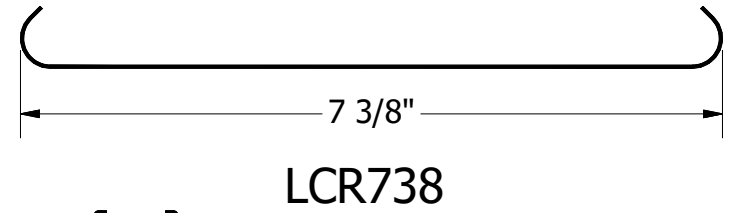
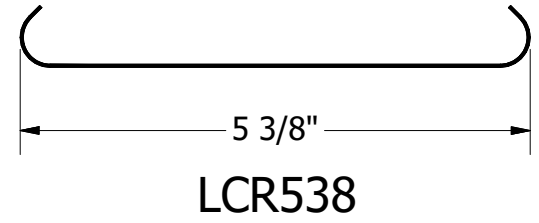
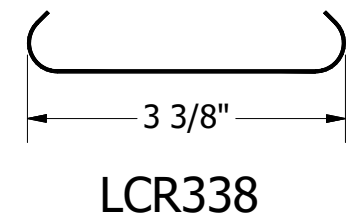

Recessed Filler Strip



Flush Filler Strip

Recessed Filler Strip

ATAS INTERNATIONAL, INC
 Allentown PA
 610-395-8445
 Mesa AZ
 480-558-7210

TITLE Linear Ceiling Panel Profile Detail

02	3/19/2025	Added LCB138 and LCB120	KRK	DWG. NO.	DR	KRK	DATE	5/29/2018
01	12/19/2022	Added LCB538 and LCR538	KRK	MATERIAL	APP		DATE	
REV. NO.	DATE	DESCRIPTION OF REVISION	BY	APP	SH. SIZE	A	SCALE	X:X

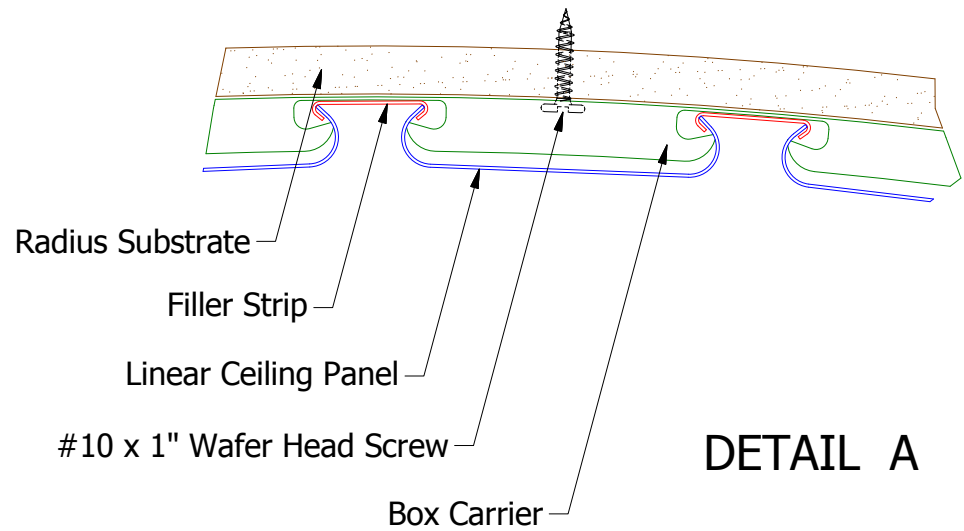
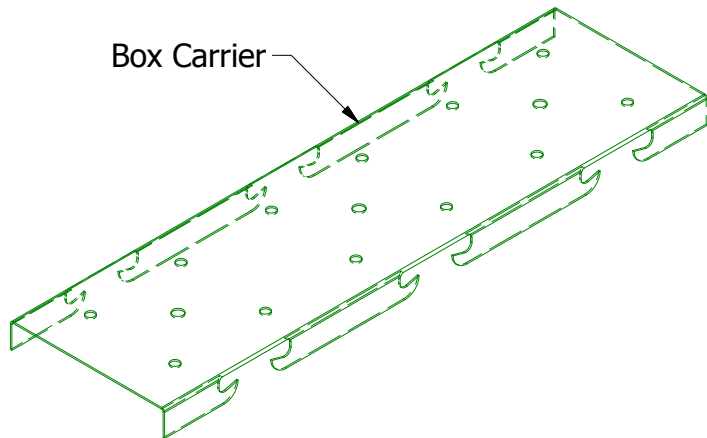
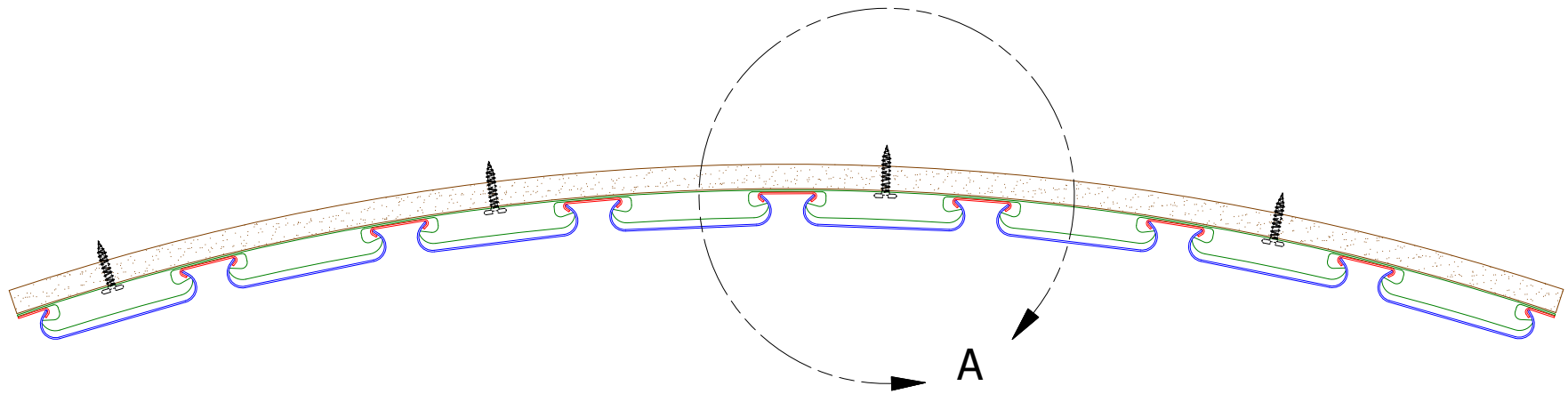

DETAIL A

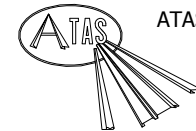

ATAS INTERNATIONAL, INC
 Allentown PA
 610-395-8445
 Mesa AZ
 480-558-7210

TITLE **Linear Ceiling Radius Detail**

REV. NO.	DATE	DESCRIPTION OF REVISION	BY	APP	DWG. NO.	DR KRK	DATE 2/20/2018
					MATERIAL	APP	DATE
						SH. SIZE A	SCALE X:X

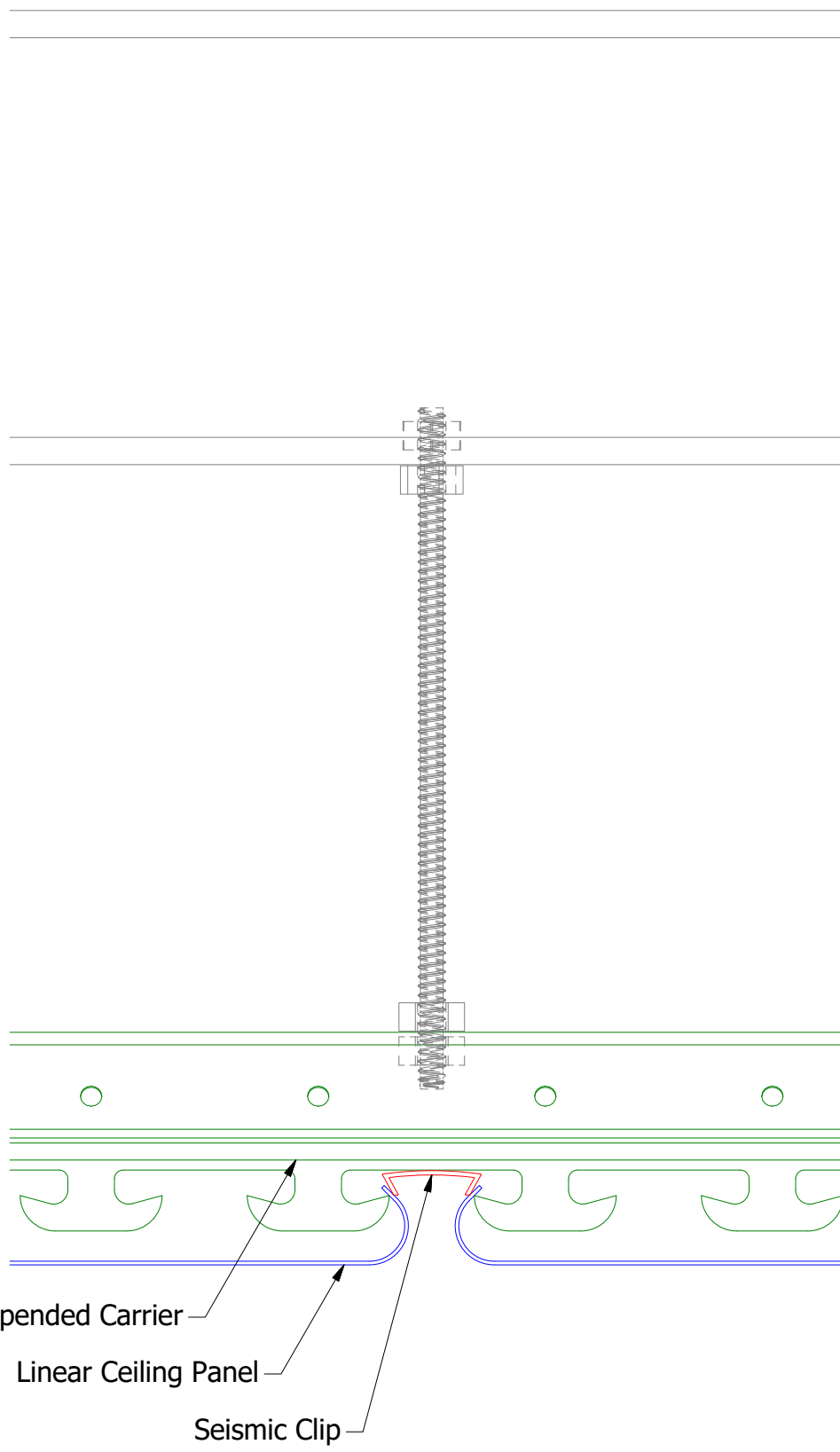

Suspended Carrier
 Linear Ceiling Panel
 Seismic Clip

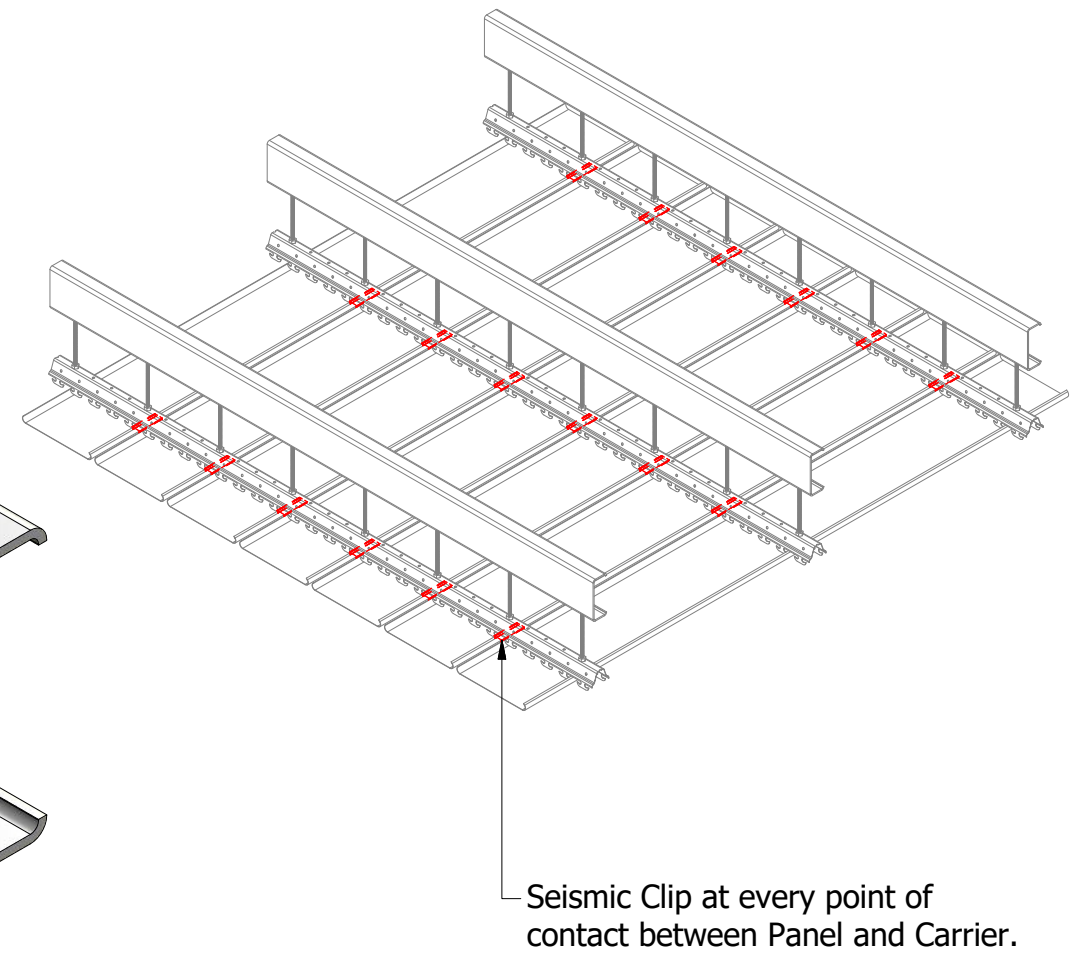
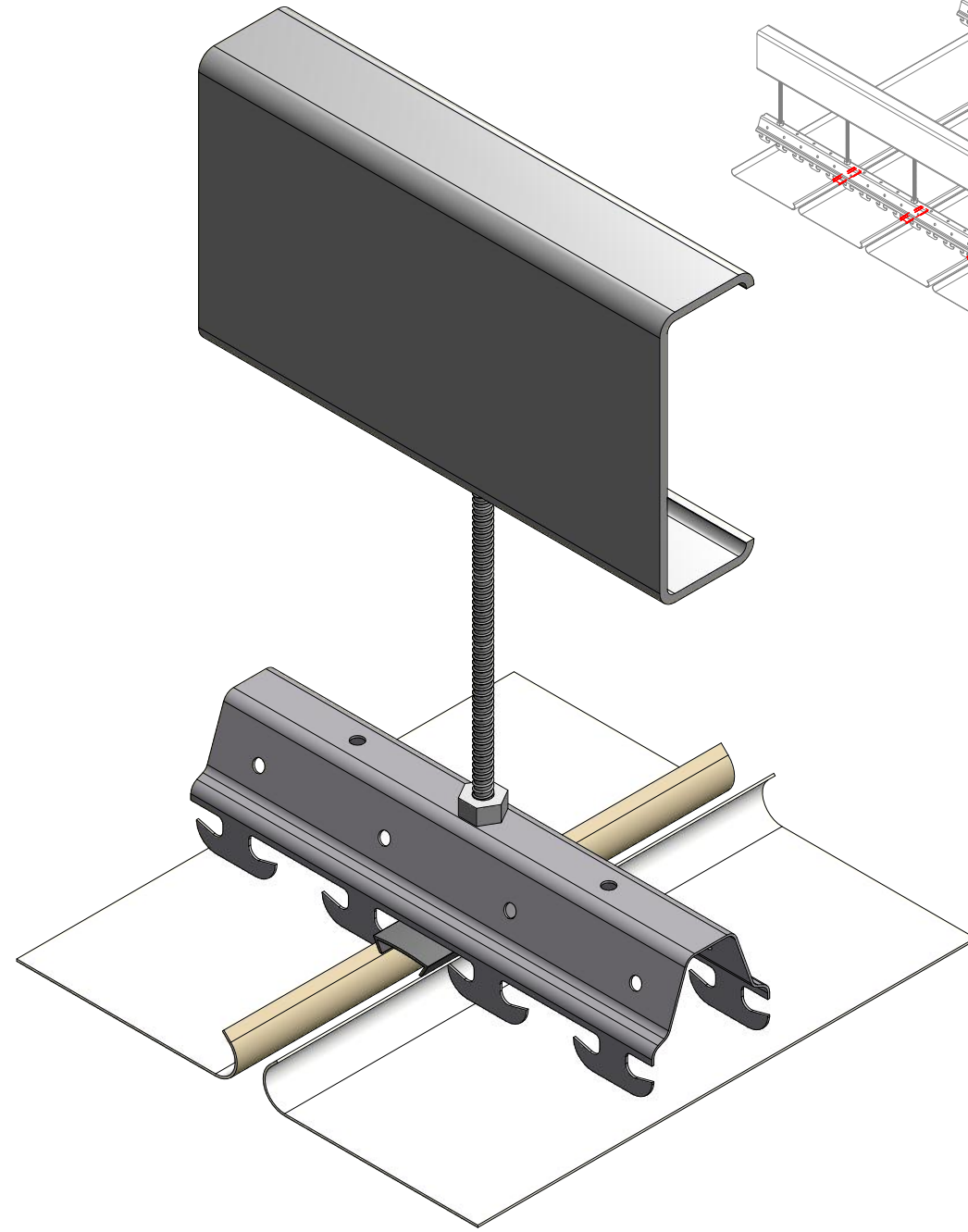

Seismic Clip at every point of contact between Panel and Carrier.

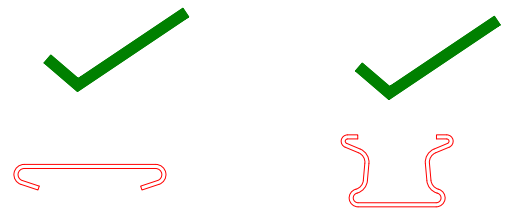

Note: Seismic Clip can be used with both Recessed Filler Strip and Flush Filler Strip

ATAS INTERNATIONAL, INC
 Allentown PA
 610-395-8445
 Mesa AZ
 480-558-7210

TITLE		Linear Ceiling Seismic Clip Detail		
DWG. NO.	DR	KRK	DATE	5/30/2018
REV. NO.	DATE	DESCRIPTION OF REVISION	BY	APP
01	2/9/2024	Updated Carrier	KRK	
			SH. SIZE	B
			SCALE	X:X

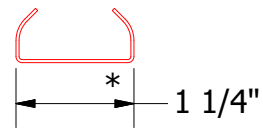

Splice for LCB138

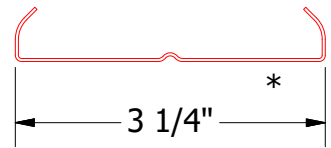

Splice for LCB338

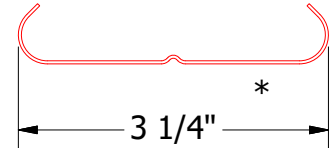

Splice for LCR338

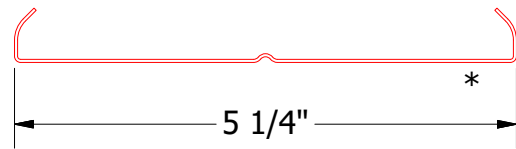

Splice for LCB538

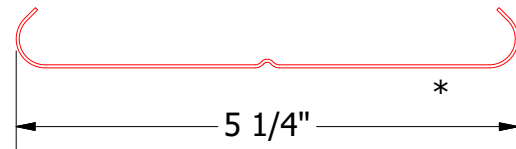

Splice for LCR538

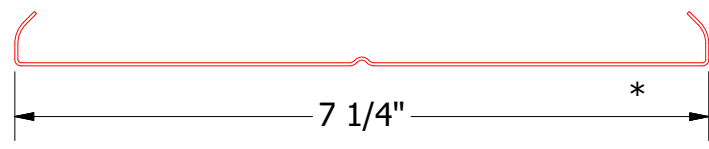

Splice for LCB738

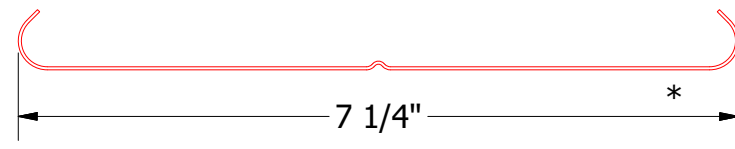

Splice for LCR738

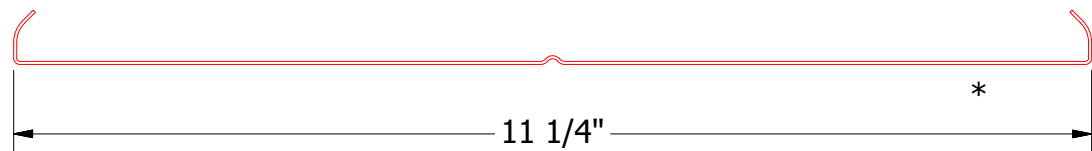

Splice for LCB120

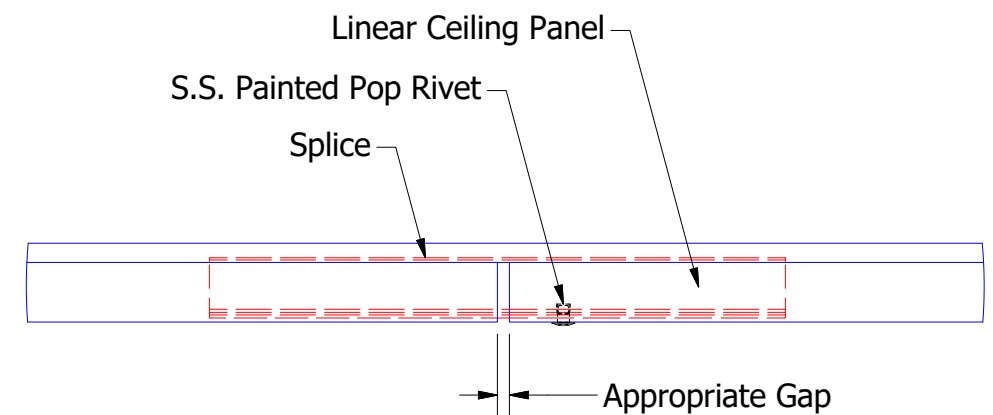
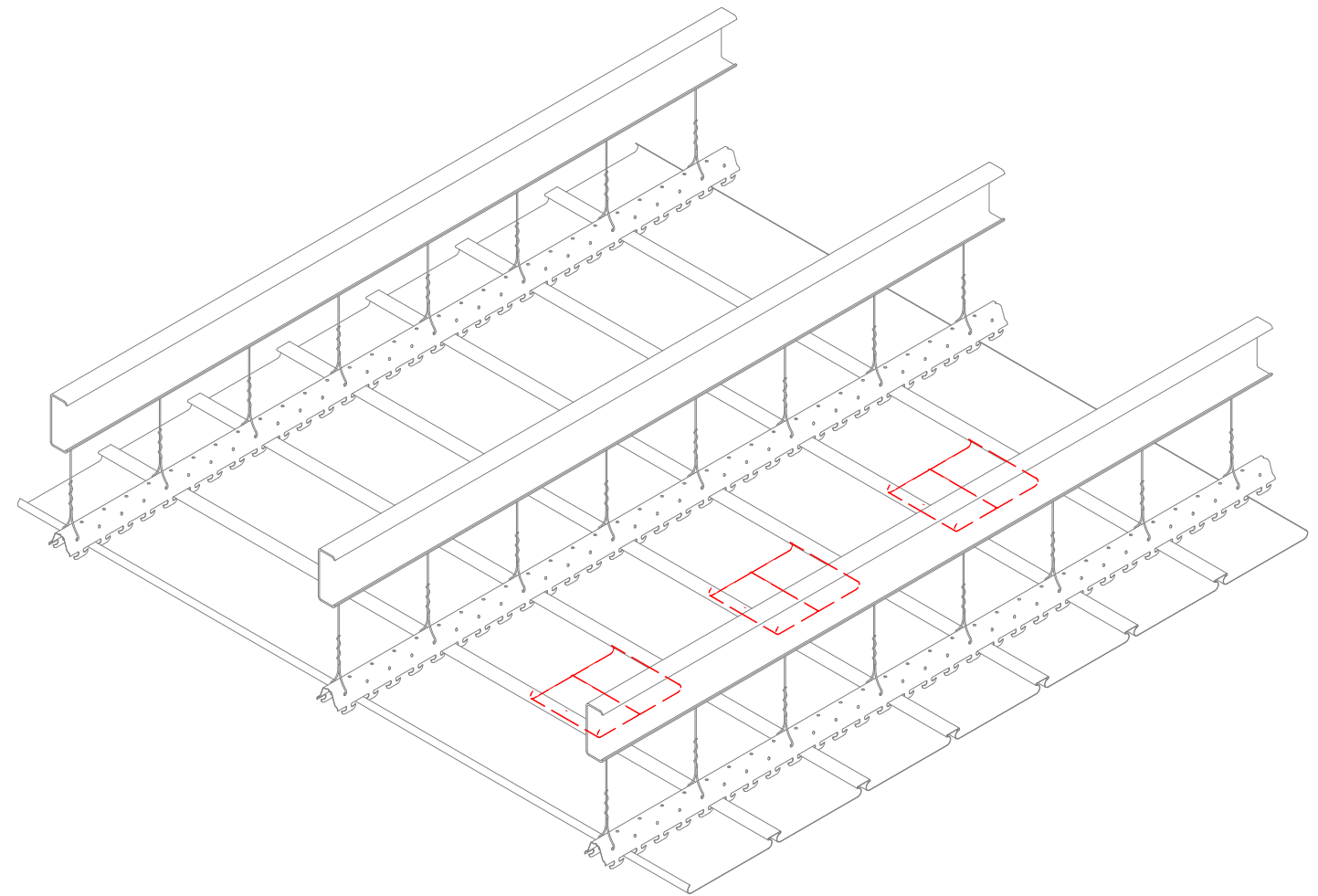
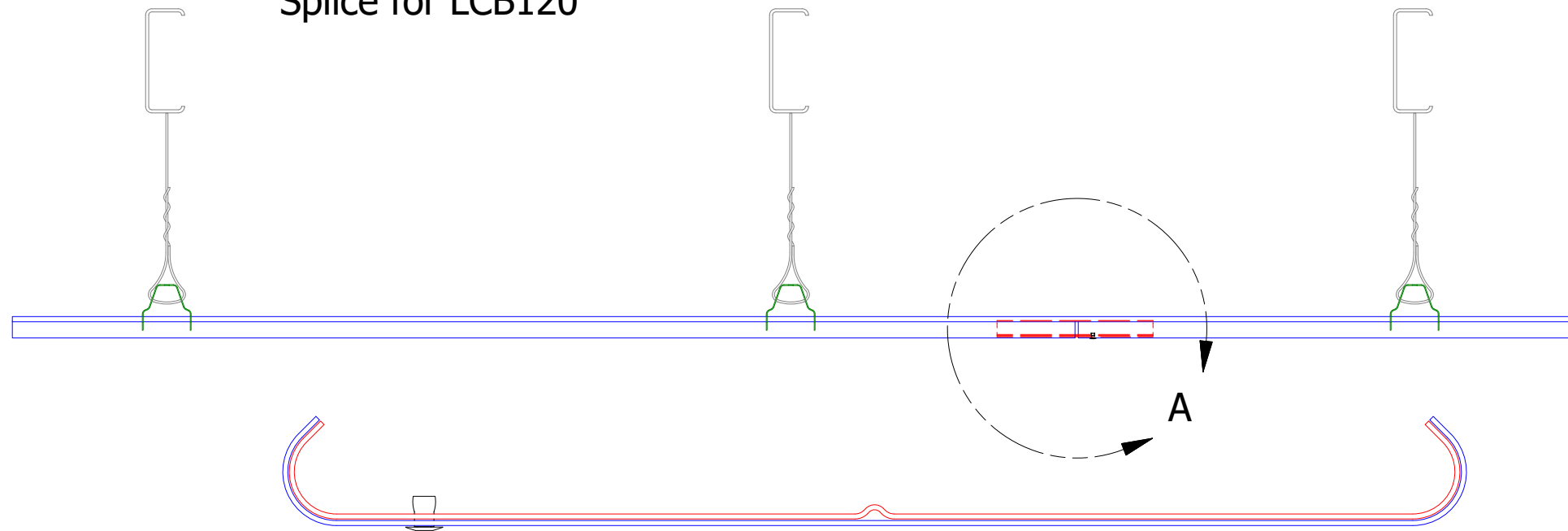

DETAIL A

Note: * denotes color side.

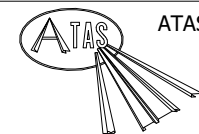

ATAS INTERNATIONAL, INC
Allentown PA
610-395-8445
Mesa AZ
480-558-7210

REV. NO.	DATE	DESCRIPTION OF REVISION	BY	APP	TITLE	DR	DATE	
03	03/19/2025	Added Splice for LCB138 and LCB120	KRK		Linear Ceiling Splice Detail			
02	2/21/2024	Added Splice Details for Box Style Panels Updated Carrier Style	KRK			DWG. NO.	DR KRK	DATE 5/30/2018
01	12/19/2022	Updated Splice Dimensions	KRK			MATERIAL	APP	DATE
						SH. SIZE	B SCALE X:X	

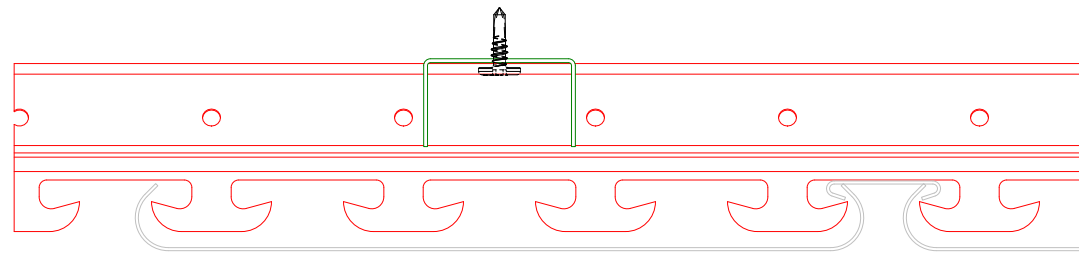

SECTION A-A

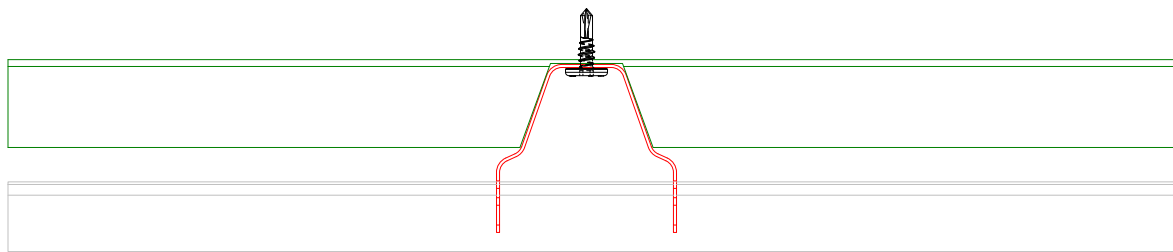

SECTION B-B

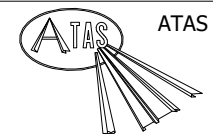
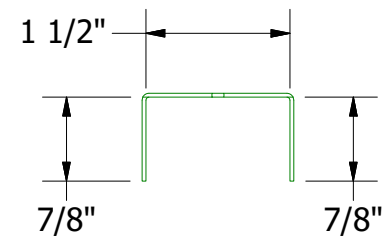
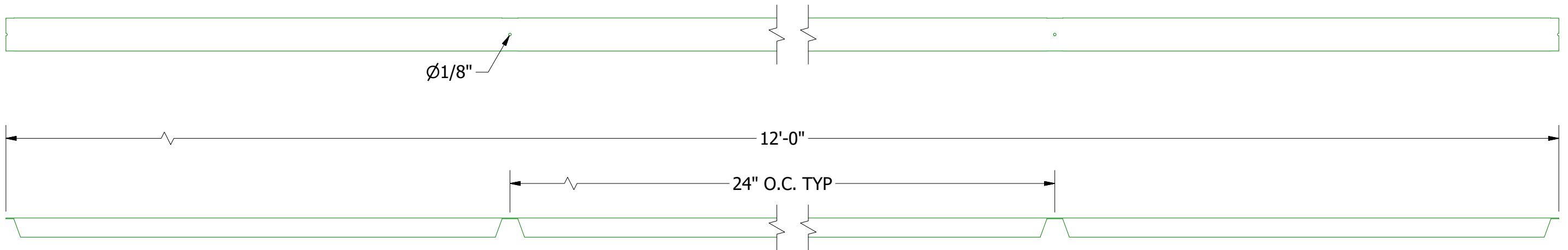
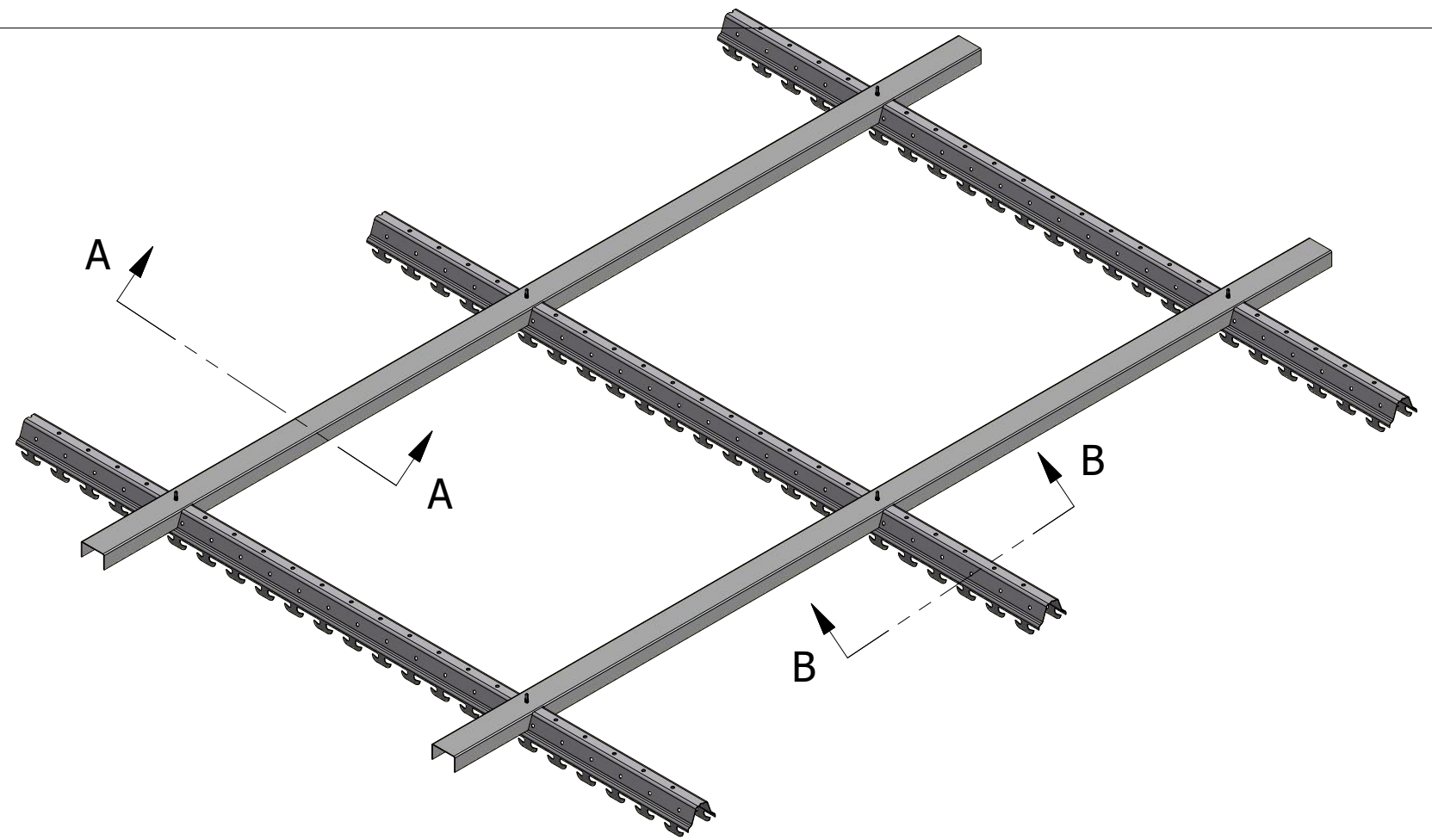

ATAS INTERNATIONAL, INC
 Allentown PA
 610-395-8445
 Mesa AZ
 480-558-7210

TITLE
Linear Ceiling Cross Carrier Spacer Detail

						DWG. NO.	DR	KRK	DATE	6/8/2023
01	2/13/2024	Updated Carrier	KRK			MATERIAL	APP		DATE	
REV. NO.	DATE	DESCRIPTION OF REVISION	BY	APP		SH. SIZE	B	SCALE	X:X	