



ATAS International, Inc.
Sustainable Solutions For A Better Future

INTERIOR APPLICATIONS

Walls & Ceilings

CONTENTS

INTERIOR APPLICATIONS

Wall Applications	4-5
Column Covers & Beam Wraps	9

PERFORATED & ACOUSTICAL WALLS

Gaten Series™ & Microperforations	6
Acoustical Wall Panels & Baffles	8
Metal Composite Material	9

ACOUSTICAL & NON-ACOUSTICAL CEILINGS

SOUNDTEX® & CFAB Cellulose Insulation Sound Absorption	10
Acoustical Performance Test Method	10
Lineair Linear Ceiling™	11-13
Lineair Opaline™	15-16

SPECIALTY CEILINGS

Lineair Torsion Spring System	17
Lineair Suspended Edge	20
Lineair Metal Panel Lay-in System	21
Lineair Plank	22

METALWÉRKS® SERIES	24-27
--------------------------	-------

OVERVIEW

With uninterrupted shadow lines and a sleek, continuous appearance, concealed and exposed fastener wall and ceiling panels offer design solutions for any number of project objectives:

- Vertical or horizontal applications
- Ribbed and corrugated panel styles
- Standing seam; batten, plank, or barn board styles
- With or without perforations
- Curved applications
- Acoustical applications
- Large format application available in wide material thickness options
- Metal composite material...and more.

In addition to the vast selection of styles and material choices, a number of the ATAS profiles can be mixed and matched seamlessly, with single or multi-color design palettes.

ATAS is proud to introduce the new Lineair series of metal ceiling systems. As the amount of metal being used in interior applications, for both ceilings and walls, is increasing, it made sense to expand our ceiling system offering. The Lineair Series brand name of ceiling products was chosen as a nod to our founders' Dutch heritage, as Lineair is Dutch for Linear. As well, Lineair is a perfect product descriptor, as our ceiling systems are actually creating lines in the air.

LONGEVITY FEATURES

- Fire resistant - will not burn or support combustion
- Minimal maintenance
- Will not warp, crack, or rot
- Industry leading long-term warranty
- High quality and time-proven finish and pretreatment technologies

University of Arkansas Art Department
Fayetteville, AR
Perforated Belvedere 6" Short Rib in Ascot White



WALL APPLICATIONS

OVERVIEW

From a functional and aesthetically pleasing linear ceiling system, to a wide variety of attractive wall panel options, a building's interior can benefit from the beauty and durability of metal. Curved, tapered, texture, color, wood look, and custom capabilities expand your options and bring design ideas to life. Acoustical sound control systems available for ceilings and walls, with NRC (Noise Reduction Coefficient) ratings of up to 1.0. Here are just some examples of ATAS standard profiles that can be used in interior applications.

CONCEALED FASTENER WALL PANELS

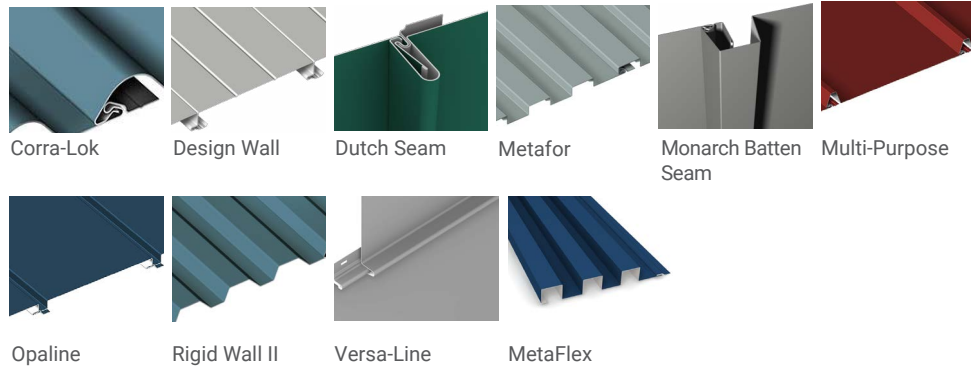

MODULAR WALL PANELS

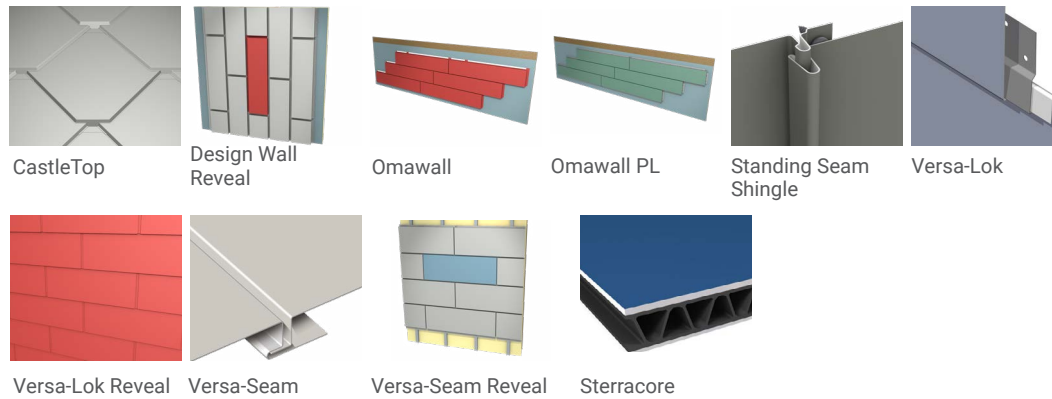

EXPOSED FASTENER WALL PANELS

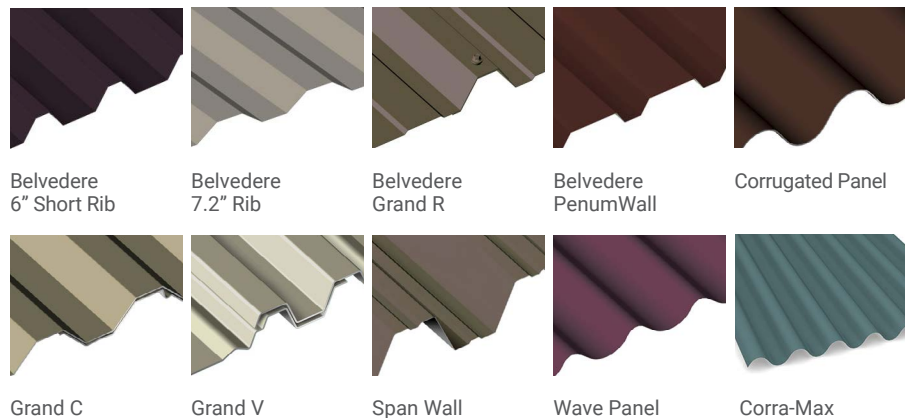



CASTLETOP & OPALINE
Black, Silversmith, Coppertone
Office, Mesa, AZ



CURVED CORRUGATED PANEL
55% Al-Zn Alloy Coated Steel With Acrylic Coated Steel
Mid Ohio Food Bank Warehouse

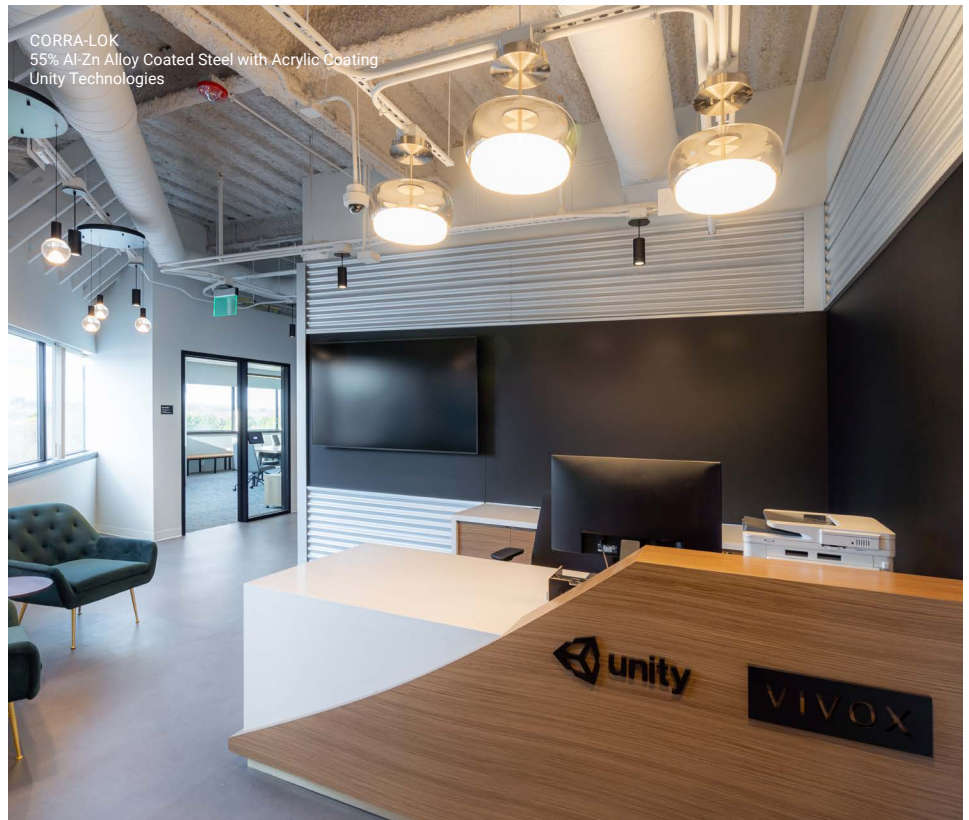

CORRA-LOK
55% Al-Zn Alloy Coated Steel with Acrylic Coating
Unity Technologies

PERFORATED & ACOUSTICAL WALLS

GATEN SERIES™ & MICROPERFORATIONS

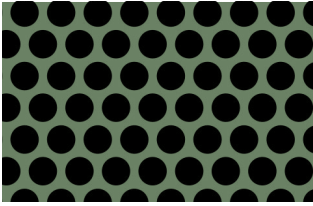

A13
 $\frac{1}{8}$ " holes | $\frac{3}{16}$ " staggered centers
 40% open area

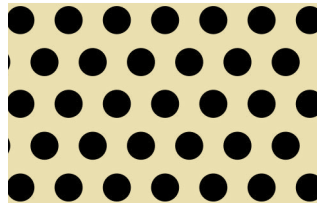

A15
 $\frac{1}{8}$ " holes | $\frac{1}{4}$ " staggered centers
 23% open area

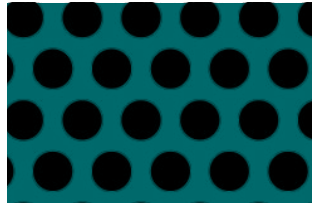

A19
 $\frac{3}{16}$ " holes | $\frac{5}{16}$ " staggered centers
 33% open area

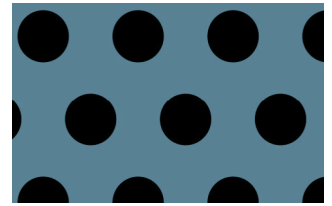

A23
 $\frac{1}{4}$ " holes | $\frac{1}{2}$ " staggered centers
 23% open area

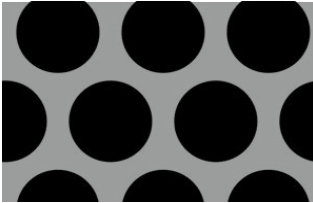

A24
 $\frac{3}{8}$ " holes | $\frac{1}{2}$ " staggered centers
 51% open area

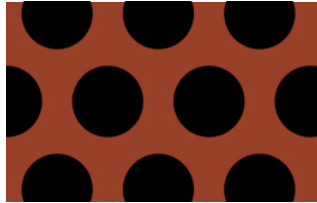

A25
 $\frac{3}{8}$ " holes | $\frac{9}{16}$ " staggered centers
 40% open area

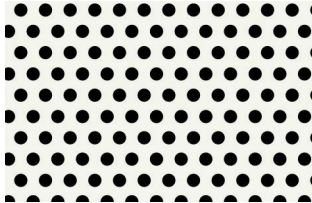

MICROPERFORATED
 $\frac{1}{16}$ " holes | $\frac{1}{8}$ " staggered centers | 22% open area
 Interior use only | For sound absorption

CONCEALED FASTENER

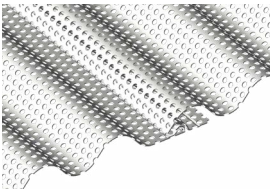

Corra-Lok

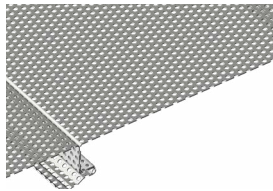

Design Wall



Metafor

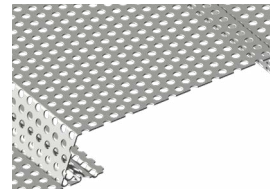

Multi-Purpose Panels



Opaline

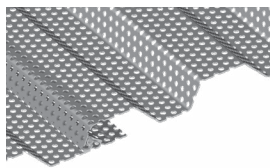

Rigid Wall II

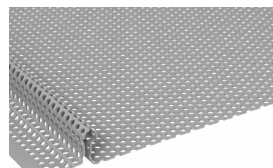

Versa-Line

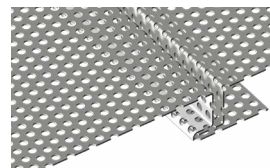

Versa-Seam

EXPOSED FASTENER

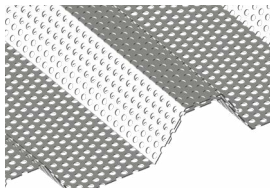

Belvedere 6" Short Rib

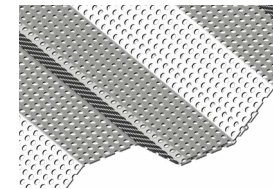

Belvedere 7.2" Rib

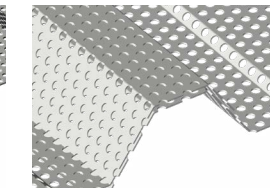

Belvedere Grand R

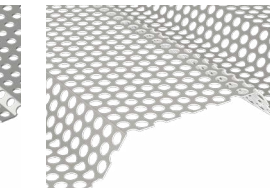

Belvedere PenumWall

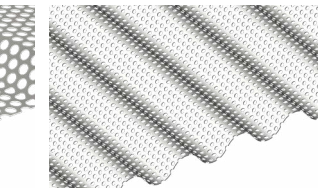

Corrugated Panel

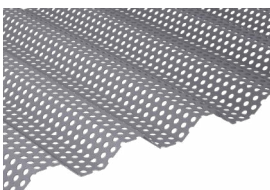

Grand C

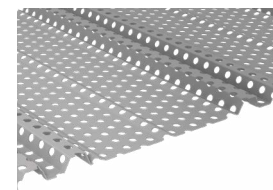

Grand V

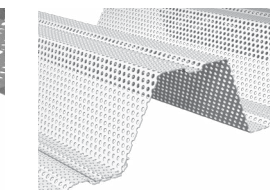

Span Wall

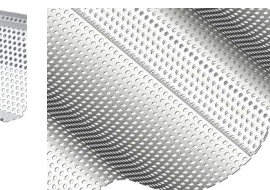

Wave Panel

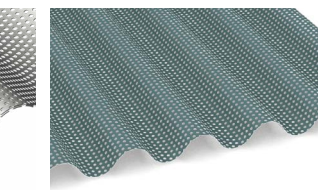

Corra-Max

RIGID WALL II
Black
Dave & Buster's

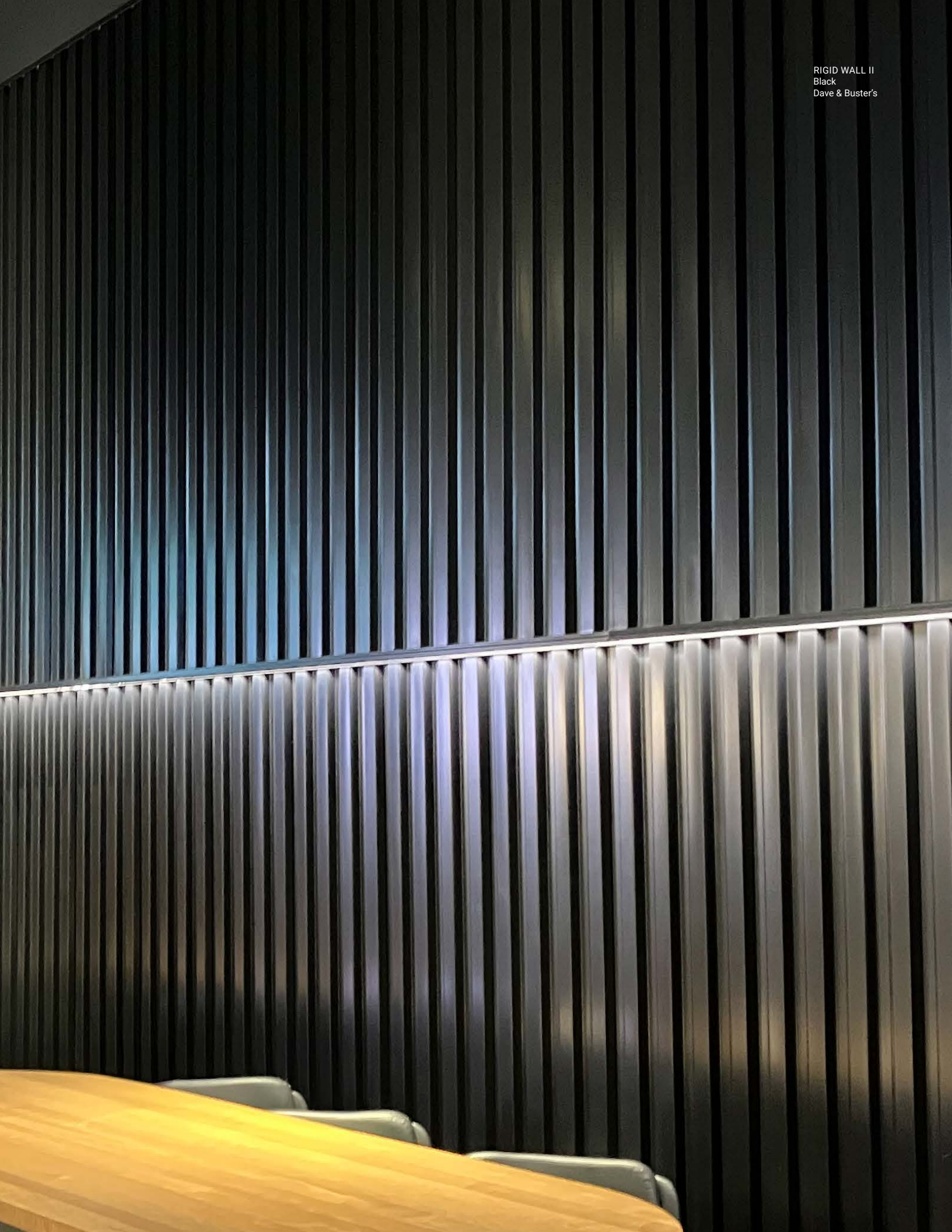

ACOUSTICAL WALL PANELS & BAFFLES

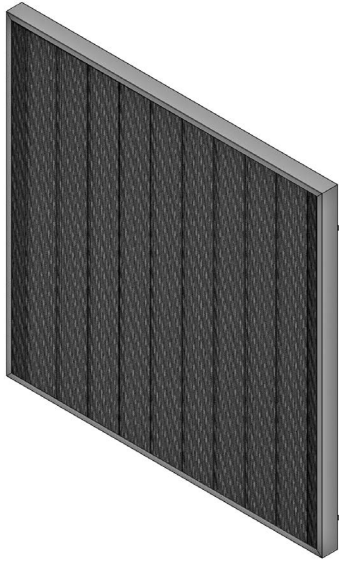

Suspended Horizontal Panel

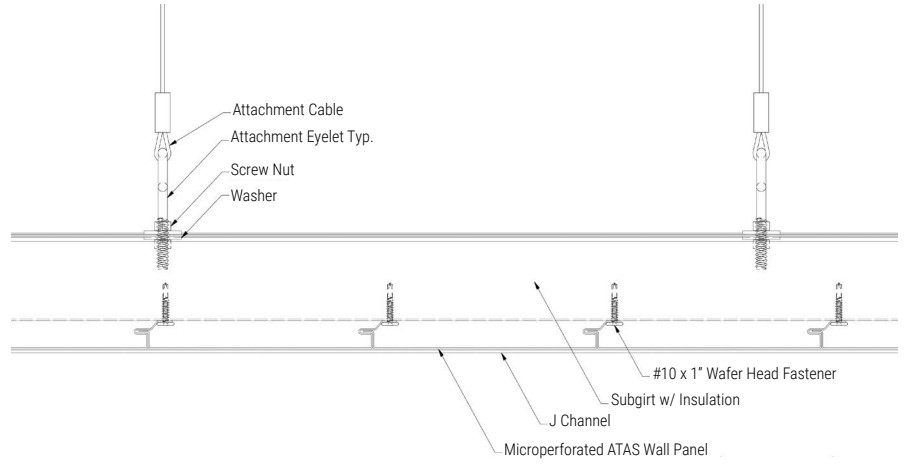

Z Bracket Wall Panel Frame Detail

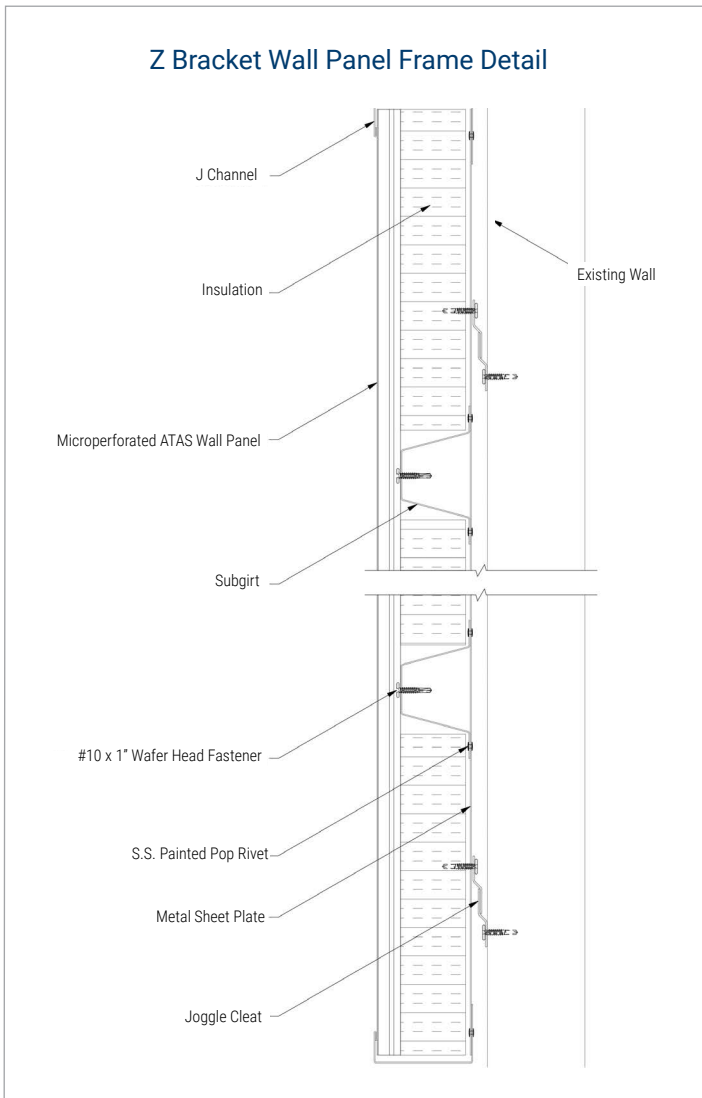

Suspended Vertical Baffle

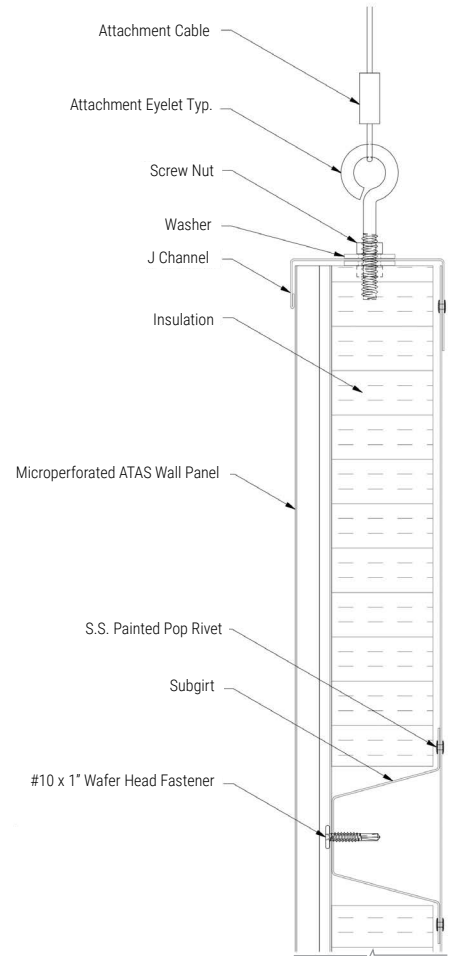

METAL COMPOSITE MATERIAL

STERRACORE

SKU: MAU999

MATERIAL

.032 aluminum exterior skin

PANEL SPECS

Coverage: 48" x 96",
48" x 120", 48" x 144"
Custom sizes available

THICKNESS

6mm

TEXTURE

Smooth or Stucco
Embossed

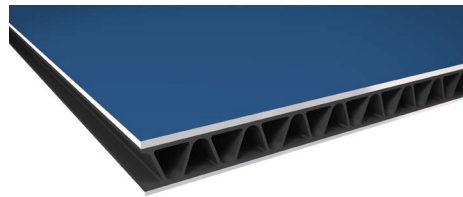

1-Piece, Module Trim



Clip & Seal



COLUMN COVERS & BEAM WRAPS

Three design options are available for the vertical jointures: a vertical formed butt joint, a vertical formed joint with reveal, and a vertical formed joint with reveal and batten type flush insert. Capitals and bases can be provided. Column covers and beam wraps are offered in a pre-painted aluminum shrouded design or post painted to achieve desired color selection. They are also available in bare aluminum and stainless steel.

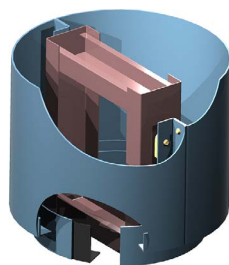

Round

VERTICAL FORMED JOINT WITH REVEAL

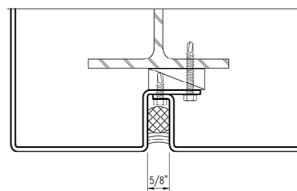

VERTICAL FORMED JOINT

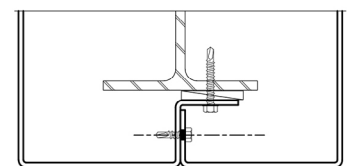

Vertical Formed Joint



Vertical Formed Joint
With Reveal

VERTICAL CURVED JOINT WITH REVEAL

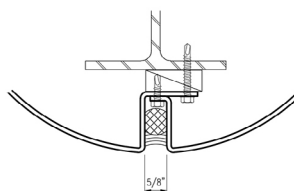

VERTICAL CURVED JOINT

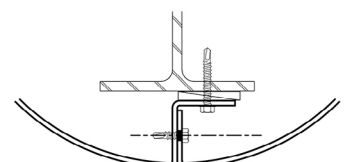

ACOUSTICAL & NON-ACOUSTICAL CEILINGS

SOUNDTEX®

SOUNDTEX® is an innovative acoustical insulation - a non-woven fabric that can be used in lieu of traditional acoustical materials where concerns about airborne glass fibers or space constraints exist. SOUNDTEX® is essentially a paper thin air filter that provides an increased resistance to airflow which dissipates sound energy by converting it into heat.

FEATURES

- Reduces reverberation
- Hot melt adhesive backing
- Available in Black
- Variety of sizes and custom options available

APPLICATIONS

- Residential
- Commercial
- Home theaters
- TV/ Media rooms
- Reverberant spaces

MATERIAL

- Ultra-thin (0.27mm incl. adhesive)
- Non-woven fabric made of cellulose and glass designed for acoustical performance

TECHNICAL PROPERTIES

- Structure of non-woven: random
- Weight: 63 g/m²
- Thickness: 0.27 mm
- Sound Impedance: 190 Ns/m.³

THE MAGIC OF SOUNDTEX®

Applied to the back of a perforated panel, the composition and superior uniformity of SOUNDTEX® allows this ultra-thin acoustical fabric to replace very bulky mineral mats, greatly saving on freight and installation costs. The air permeability of SOUNDTEX® reduces moisture in the plenum, enhances flexibility in building HVAC design, and permits thermal transfer in energy-efficient chilled ceilings.

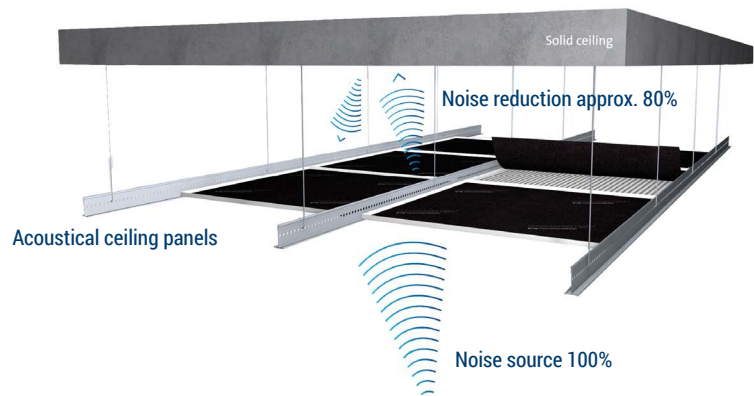

CFAB CELLULOSE INSULATION SOUND ABSORPTION



FEATURES

- Resists mold growth
- Made from renewable and recycled fibers consisting of 65-75% recycled content
- Available in 2' x 4', 4' x 4', and 4' x 8' panels
- Available in ½", 1", or 2" thickness
- Density: 3PCF -m2" thickness

PRODUCT SAFETY

- Class A fire rating
- Does not contain any harmful airborne particles and does not itch or irritate skin like fiber glass insulation

GREEN QUALITIES

- Environmentally responsible and sustainable
- Most CFAB cellulose foam board products are completely recyclable and no scrap is produced during the manufacturing process or installation of the material
- Sustainable manufacturing process reduces energy use and air pollution
- Made primarily from post-consumer, post-industrial paper using recycled newspaper as the main raw material

ACOUSTICAL PERFORMANCE

- Open design and density increases sound absorption to control and deaden sound
- CFAB cellulose foam board panels achieve high Noise Reduction Coefficient (NRC) ratings based on the density specified
- Sound Transmission Classification (STC) ratings exceed the values attained with commonly used acoustical materials

*Info provided for SOUNDTEX® and CFAB are for descriptive purposes; CFAB materials typically supplied by installer/contractor or distributor.

LINEAIR LINEAR CEILING™

SKU: Round Edge: LCR338, LCR538, LCR738
Box Style: LCB138, LCB338, LCB538, LCB738

MATERIAL

.019, .032 aluminum

PANEL SPECS

LCR Width: 3³/₈" , 5³/₈" , 7³/₈" | 4", 6", 8" coverage with filler strips

LCB Width: 1³/₈" , 3³/₈" , 5³/₈" , 7³/₈" | 2", 4", 6", 8" coverage with filler strips

Length: Minimum 4'-0", maximum 20'-0" (LCB138 is limited to a 12' length)

Height: 5/8"

AVAILABLE

Louvered/Vented

Microperforated

Mix and Match Widths

TEXTURE

Smooth

Wood Grain Embossed (.032 aluminum only)

Stucco Embossed

FINISH

70% PVDF, Mirrored, Wood Grain Finishes

COLORS

Choice of over 40 stock colors in .032 aluminum
.019 and .024 aluminum available in Bone White with a 70% PVDF finish

Custom colors available*

ANODIZED

Clear Satin, Dark Bronze, BlackMatt, LA Dark Bronze

ACCESSORIES

Suspended carrier, a complete line of trims available

CARRIER

Metal: Aluminum

Gauge: .040

Length: Standard 12'-0"

FILLER STRIPS (OPTIONAL)

Available in .019 aluminum in Black or Bone White

*Subject to minimum quantities and longer lead time.

Inquire for availability.

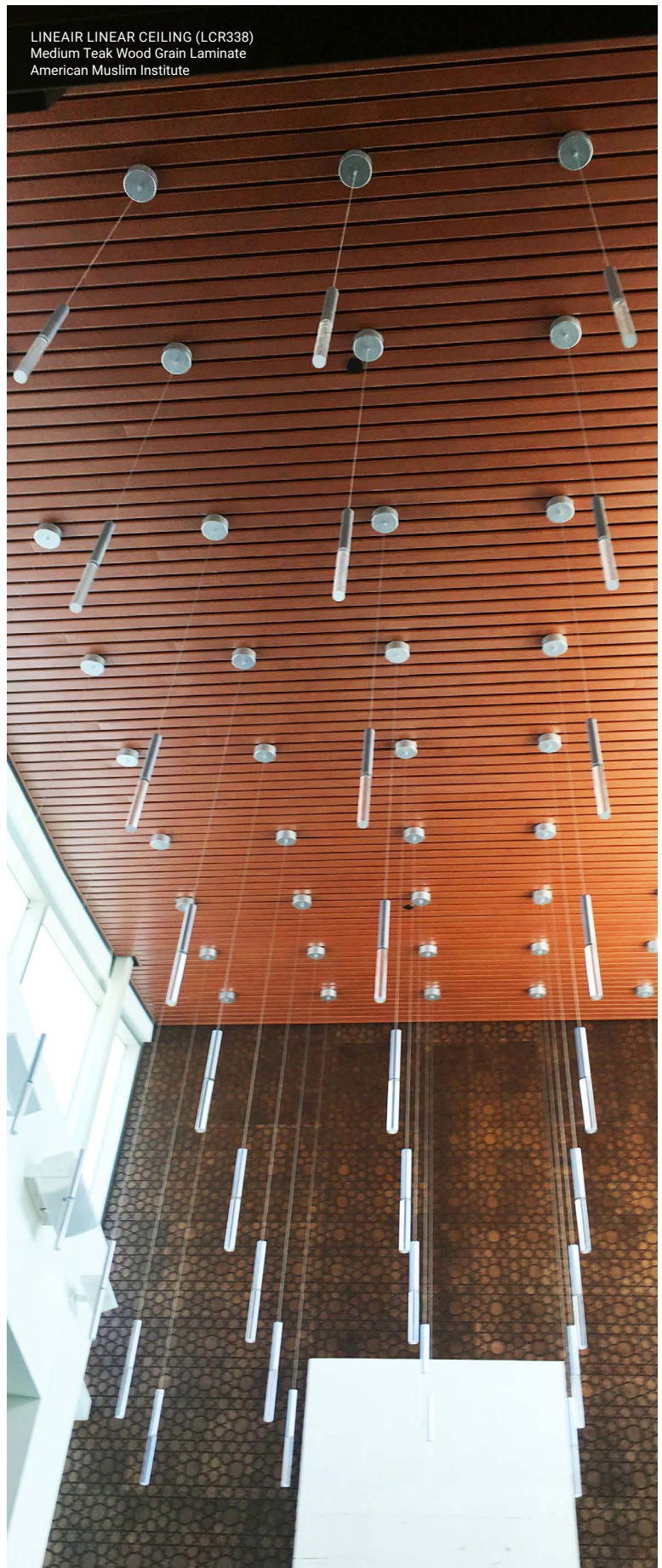

LINEAIR LINEAR CEILING™ CONTINUED

ROUND EDGE:

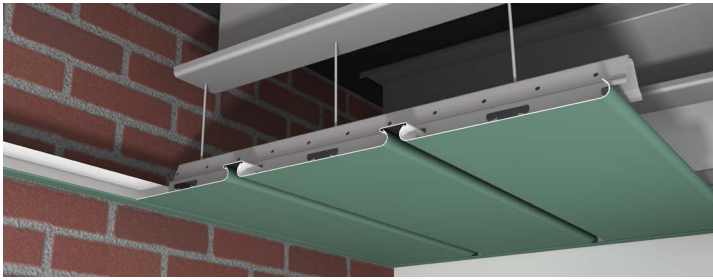

LCR with recessed filler strip

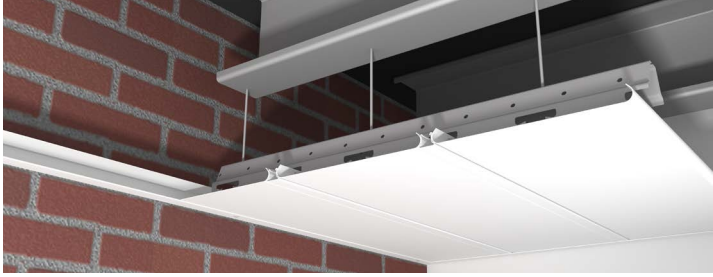

LCR with flush filler strip



LCR with mix and match widths

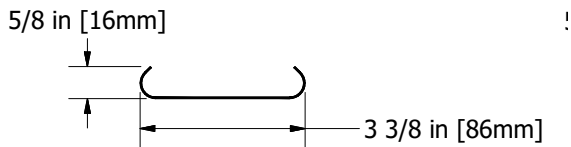

Linear Linear Ceiling (LCR338)

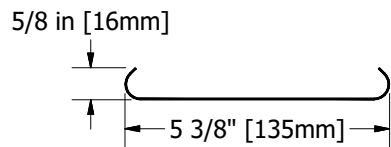

Linear Linear Ceiling (LCR538)

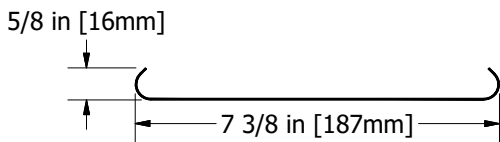

Linear Linear Ceiling (LCR738)

BOX STYLE:

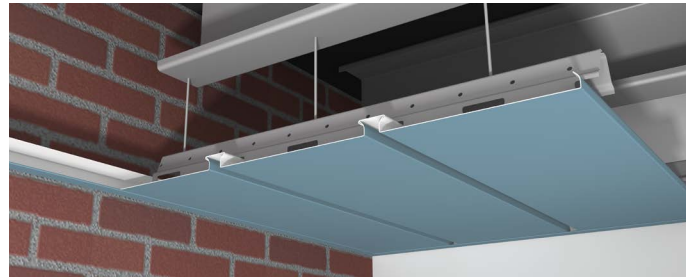

LCB with recessed filler strip

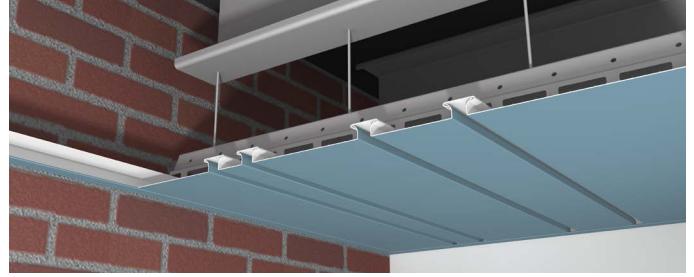

LCB with mix and match widths

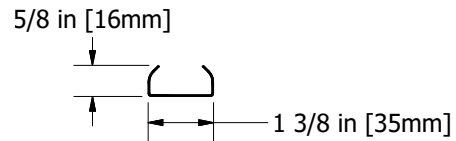

Linear Linear Ceiling (LCB138)

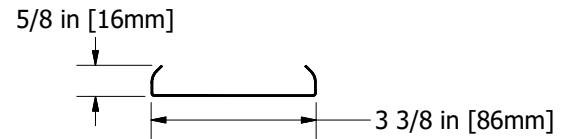

Linear Linear Ceiling (LCB338)

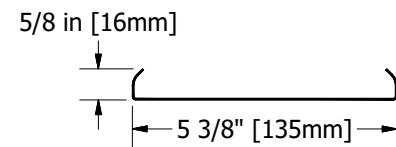

Linear Linear Ceiling (LCB538)

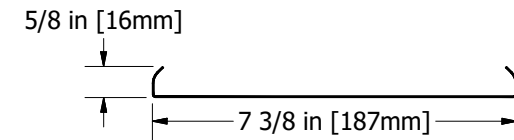

Linear Linear Ceiling (LCB738)

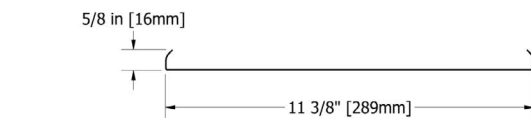

Linear Metal Ceiling (LCB120)

FILLER STRIPS:

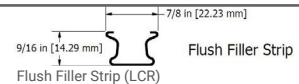

LINEAIR LINEAR CEILING™ CONTINUED



Microperforated LCR with recessed filler strip and insulation



Microperforated LCR with flush filler strip with SOUNDTEX®

MICROPERFORATED PANELS WITH SOUND ABSORPTION

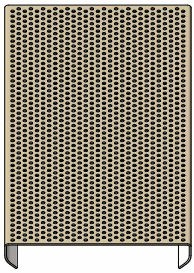

LCB338

.0625" Dia. x .125" Staggered Centers

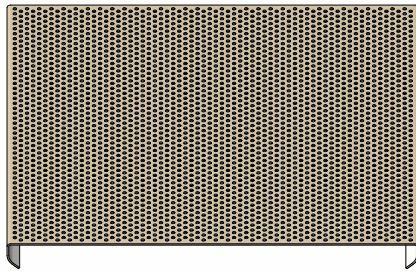

LCB738

.0625" Dia. x .125" Staggered Centers

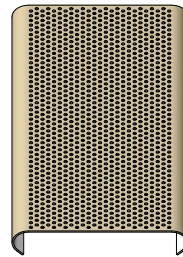

LCR338

.0625" Dia. x .125" Staggered Centers

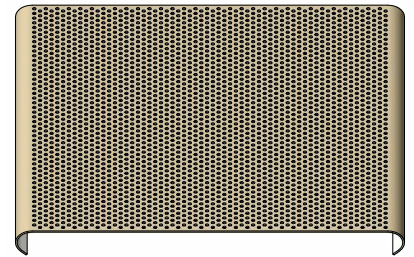

LCR738

.0625" Dia. x .125" Staggered Centers

ACOUSTICAL SOUND PERFORMANCE: ASTM C423-17 & ASTM E795-16*

SERIES/MODEL		LCR						
SAMPLE TYPE		3 ³ / ₈ " CEILING PANELS WITH SOUNDTEX®						
MOUNTING TYPE		E400						
DATA FILE NO.	1/3 OCTAVE SOUND ABSORPTION COEFFICIENTS AT THE OCTAVE BRAND FREQUENCIES						NRC	SAA
	125	250	500	1000	2000	4000		
J8807.01D	0.66	0.80	0.48	0.56	0.68	0.57	0.65	0.65

SERIES/MODEL		LCR						
SAMPLE TYPE		7 ³ / ₈ " CEILING PANELS WITH SOUNDTEX®						
MOUNTING TYPE		E400						
DATA FILE NO.	1/3 OCTAVE SOUND ABSORPTION COEFFICIENTS AT THE OCTAVE BRAND FREQUENCIES						NRC	SAA
	125	250	500	1000	2000	4000		
J8807.01C	0.69	0.85	0.52	0.59	0.71	0.55	0.65	0.68

SERIES/MODEL		LCR						
SAMPLE TYPE		3 ³ / ₈ " CEILING PANELS WITH 2" CFAB CELLULOSE INSULATION						
MOUNTING TYPE		E400						
DATA FILE NO.	1/3 OCTAVE SOUND ABSORPTION COEFFICIENTS AT THE OCTAVE BRAND FREQUENCIES						NRC	SAA
	125	250	500	1000	2000	4000		
J2523.01C	0.83	1.02	0.97	1.01	0.95	0.96	1.00	1.00

SERIES/MODEL		LCR						
SAMPLE TYPE		7 ³ / ₈ " CEILING PANELS WITH 2" CFAB CELLULOSE INSULATION						
MOUNTING TYPE		E400						
DATA FILE NO.	1/3 OCTAVE SOUND ABSORPTION COEFFICIENTS AT THE OCTAVE BRAND FREQUENCIES						NRC	SAA
	125	250	500	1000	2000	4000		
J2523.01D	0.81	1.03	0.98	1.01	0.95	0.96	1.00	1.00

*See ASTM manual for details on acoustical performance test methods.

LINEAIR LINEAR CEILING (LCR738)
Custom Wood Grain 2-Coat with Black recessed filler strips
Moser School
Photo Credit: Michael Petrocelli



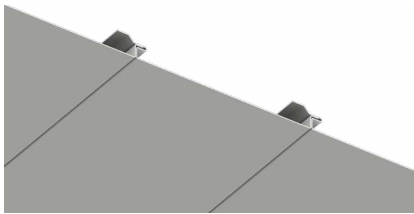

OPF

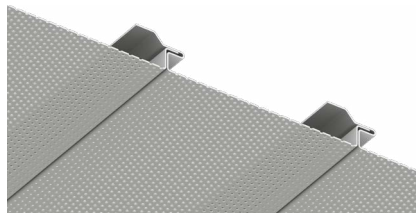

OPF with Microperforations

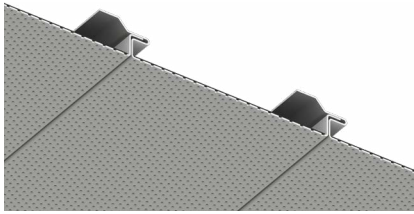

OPF with Microperforations & SOUNDTEX®

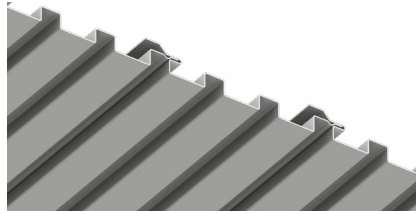

OPM

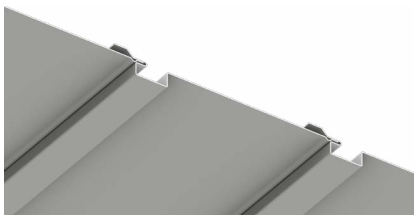

OPN

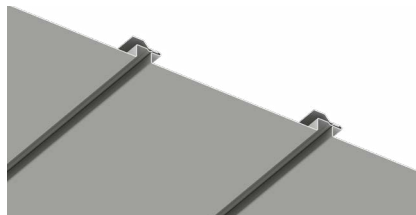

OPW

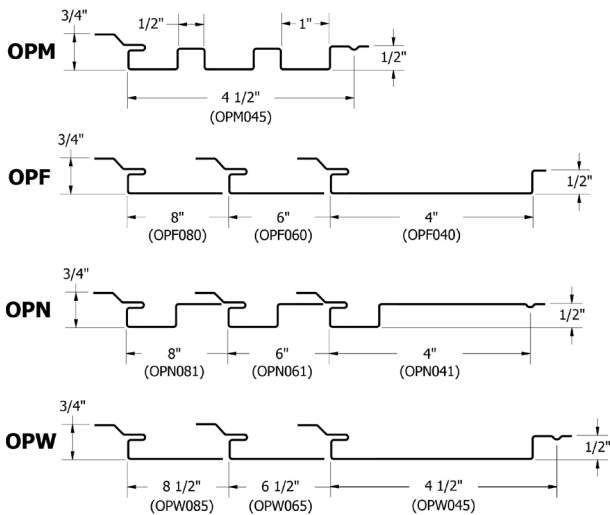

LINEAIR OPALINE™

SKU: OPF, OPM, OPN, OPW

MATERIAL

.032, .040 aluminum
 24 ga. metallic coated steel

PANEL SPECS

Coverage: OPF: 4", 6", 8"
 OPM: 4 1/2"
 OPN: 4", 6", 8"
 OPW: 4 1/2", 6 1/2", 8 1/2"
 Minimum Length: 1'-6"
 Depth: 3/4"

TEXTURE

Smooth, Stucco Embossed, or
 Wood Grain Embossed

FINISH

70% PVDF, Wood Grain Finishes

COLORS

Choice of over 40 stock colors
 Custom colors available*

CARRIER

Linear Opaline is available with a suspended snap-in carrier or is mechanically attached. Only OPF and OPW may be installed with the snap-in carrier.

*Subject to minimum quantities and longer lead time. Inquire for availability.



Flush Linear Opaline (OPF) Ceiling with Snap In Carrier



Reveal Linear Opaline (OPW) Ceiling with Snap In Carrier

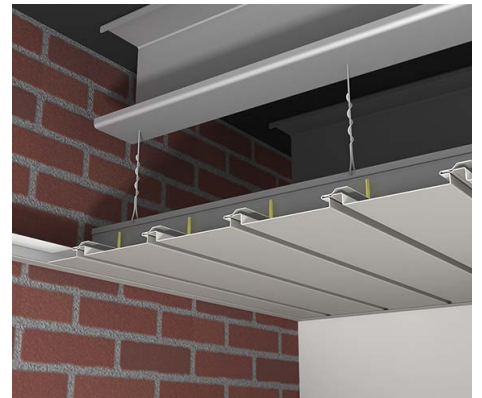

Reveal Linear Opaline (OPW) Ceiling with Snap In Carrier Mechanically Attached to a Drywall Grid

LINEAIR OPALINE CONTINUED

MICROPERFORATED PANELS WITH SOUND ABSORPTION

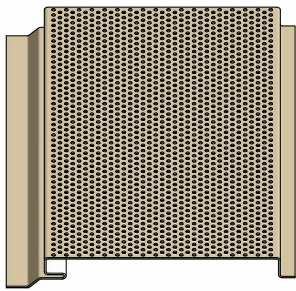

OPF040

.0625" Dia. x .125" Staggered Centers

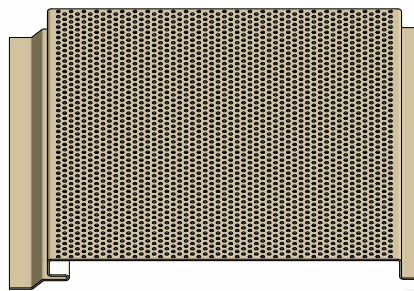

OPF060

.0625" Dia. x .125" Staggered Centers

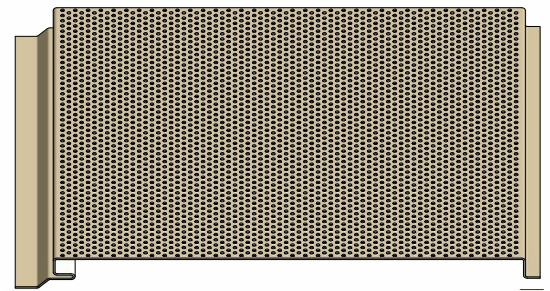

OPF080

.0625" Dia. x .125" Staggered Centers

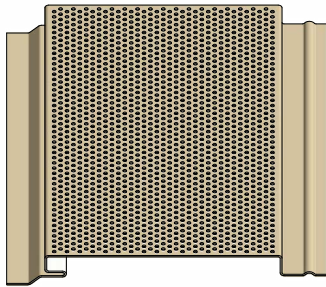

OPW045

.0625" Dia. x .125" Staggered Centers

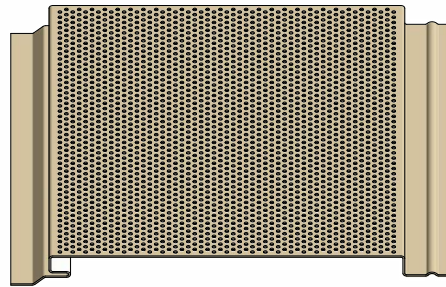

OPW065

.0625" Dia. x .125" Staggered Centers

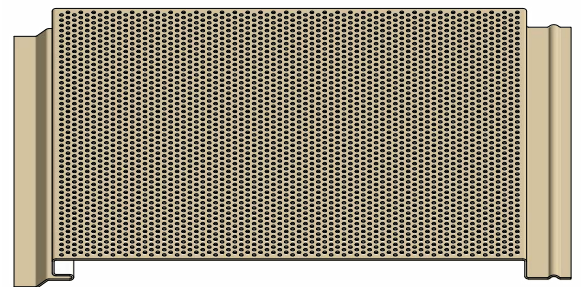

OPW085

.0625" Dia. x .125" Staggered Centers

ACOUSTICAL SOUND PERFORMANCE: ASTM C423-17 & ASTM E795-16*

SERIES/MODEL	OPW							
SAMPLE TYPE	6" CEILING PANELS WITH SOUNDTEX®							
MOUNTING TYPE	E400							
DATA FILE NO.	1/3 OCTAVE SOUND ABSORPTION COEFFICIENTS AT THE OCTAVE BRAND FREQUENCIES						NRC	SAA
	125	250	500	1000	2000	4000		
J2520.01A	0.78	0.90	0.56	0.61	0.66	0.70	0.70	0.70

SERIES/MODEL	OPW							
SAMPLE TYPE	6" CEILING PANELS WITH 2½" FIBERGLASS INSULATION							
MOUNTING TYPE	E400							
DATA FILE NO.	1/3 OCTAVE SOUND ABSORPTION COEFFICIENTS AT THE OCTAVE BRAND FREQUENCIES						NRC	SAA
	125	250	500	1000	2000	4000		
J2520.01B	0.92	1.04	0.97	0.98	0.91	0.87	1.00	0.99

*See ASTM manual for details on acoustical performance test methods.



LINEAIR OPALINE
55% Al-Zn Alloy Coated Steel With Acrylic Coated Steel
American Metal Supply

SPECIALTY CEILINGS

LINEAR TORSION SPRING SYSTEM

PANEL SIZE

Inquire for material and panel coverage availability

MATERIAL

Panels: .032, .040, .050, .063, & .080 aluminum
T-Bar Suspension: .021 (standard) galvanized steel, .024 (heavy duty) galvanized steel

COLORS

Choice of over 40 stock colors
Custom colors and finishes available

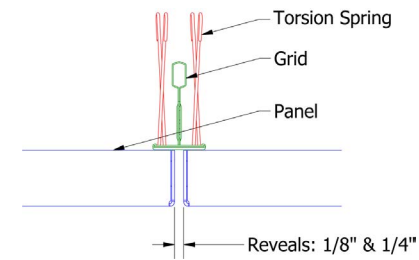
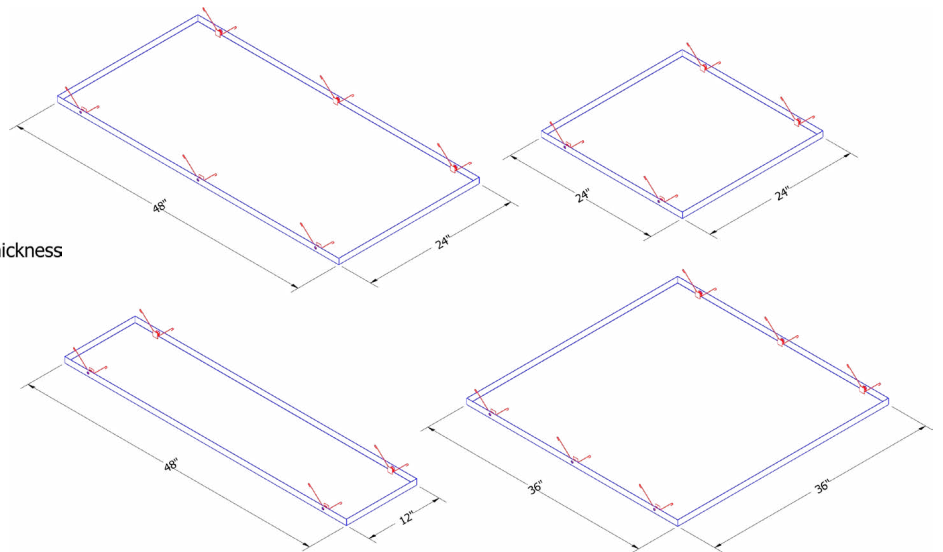
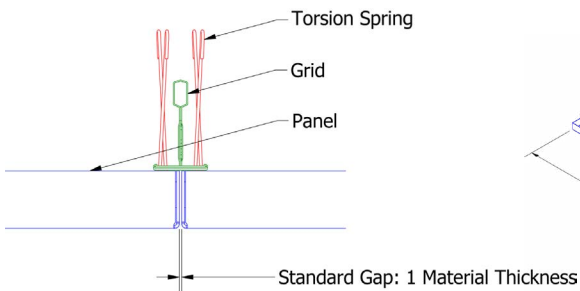

LINEAR PLANK CEILING
White
Rose Garden Tea Room



LINEAIR LINEAR CEILING
Dark Teak
Quadrant Information Security





LINEAR SUSPENDED EDGE STANDARD & RADIUS ED TRIM SIZE

Face Size: 2" 4", 6", 8"

Custom: 1" increments to 24"

Standard length is 12'-0" for straight sections

MATERIAL

Panels: .032, .040, .050, .063, & .080 aluminum

COLORS

Choice of over 40 stock colors

Custom colors and finishes available

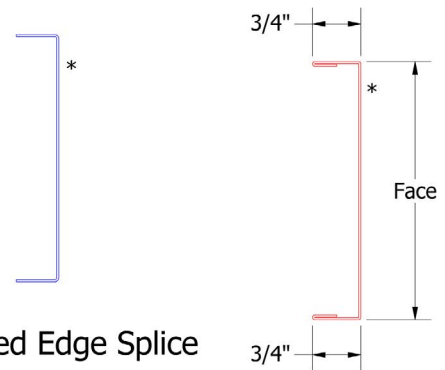
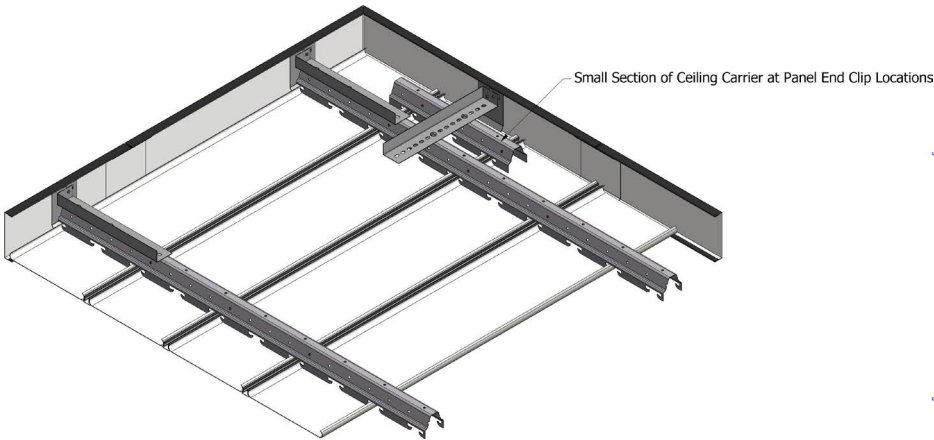

Suspended Edge Splice

Suspended Edge Trim

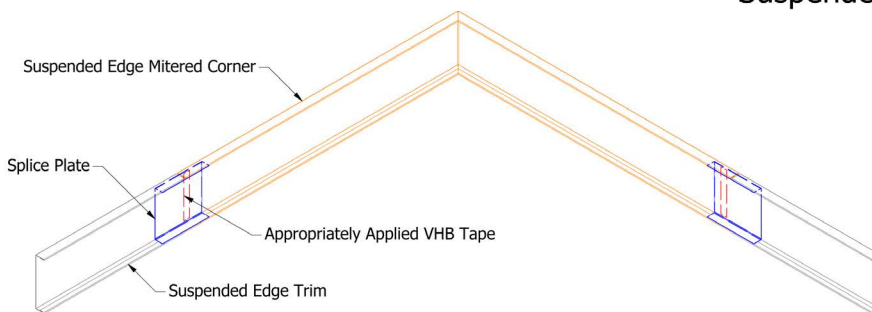

Note: * denotes color side.

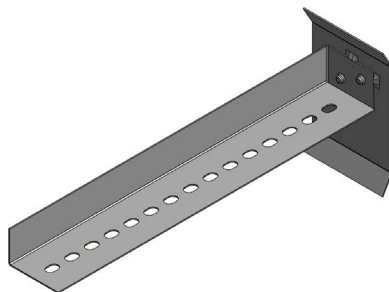

Suspended Edge Clip
(20ga Steel)

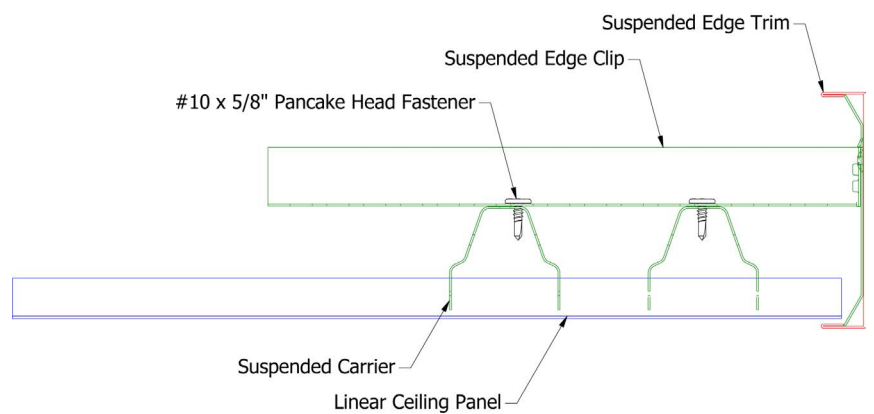

LINEAIR METAL PANEL LAY-IN SYSTEM

PANEL SIZE

Inquire for material and panel coverage availability

MATERIAL

Panels: .032, .040, .050, .063, & .080 aluminum
T-Bar Suspension: .021 (standard) galvanized steel,
.024 (heavy duty) galvanized steel

COLORS

Choice of over 40 stock colors
Custom colors and finishes available

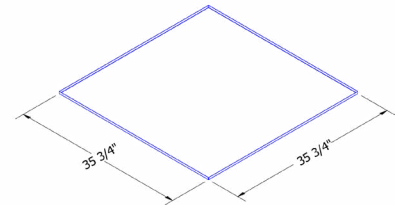
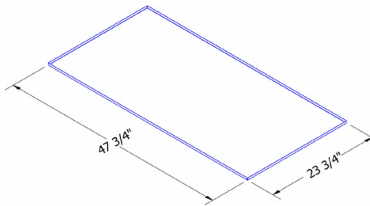
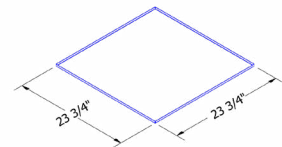
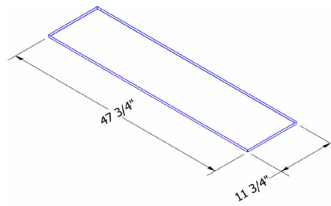
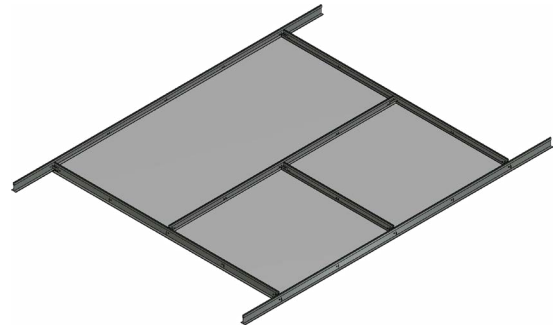
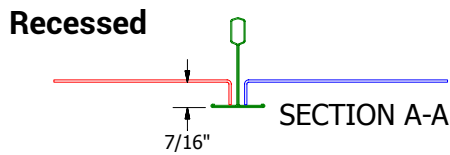
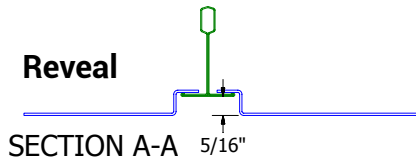
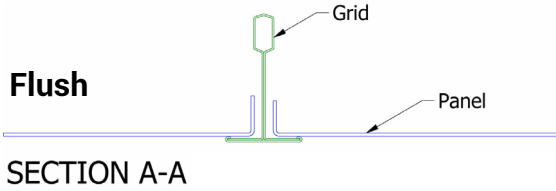
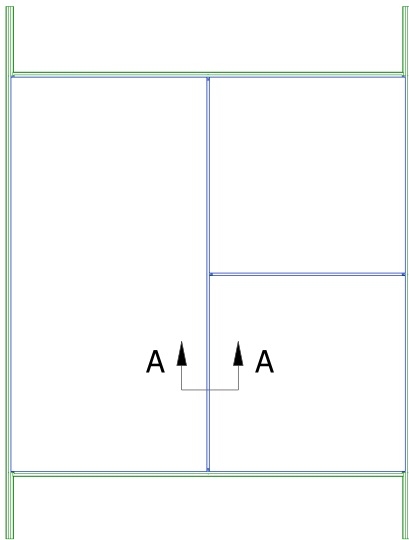



LINEAIR PLANK

PANEL SIZE

Inquire for material and panel coverage availability

MATERIAL

Panels: .032, .040, .050, & .063 aluminum

COLORS

Choice of over 40 stock colors

Custom colors and finishes available

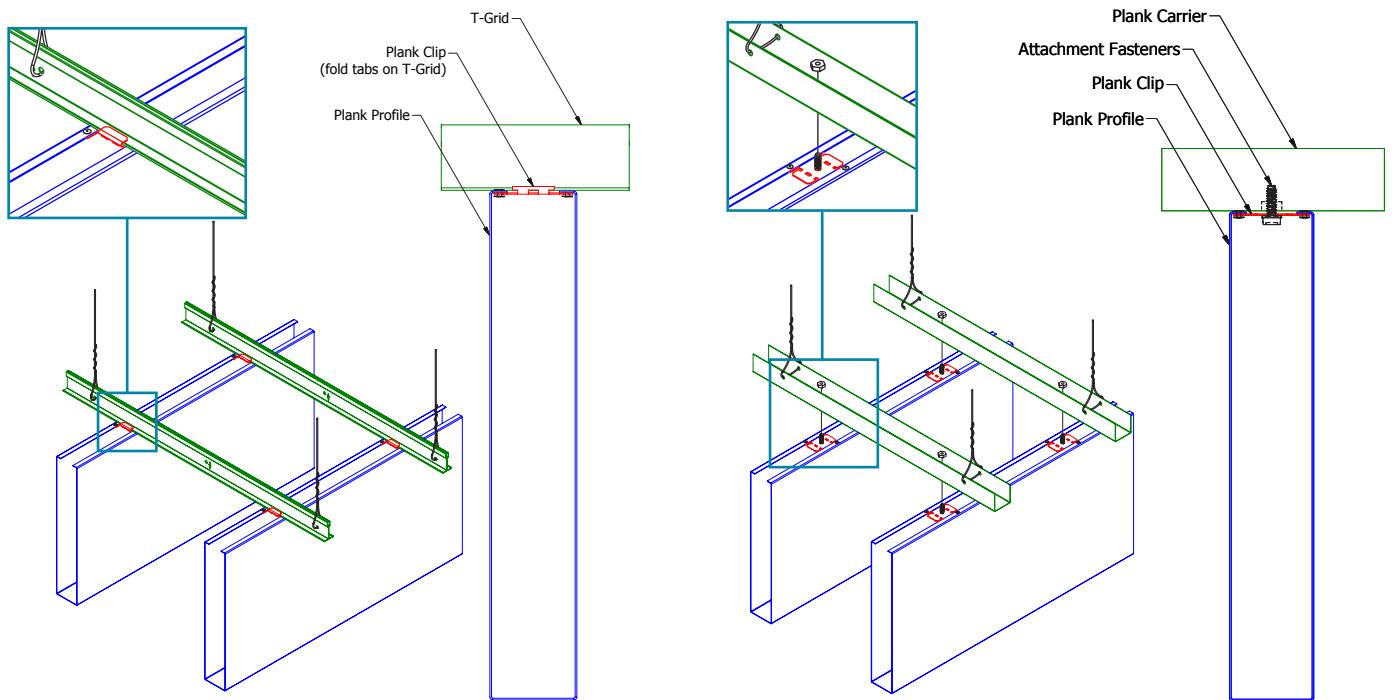



CASTLETOP
Siam Blue, Regal Blue
Silversmith & Bone White

LINEAIR LINEAR CEILING
Custom Finish

Office, Allentown, PA

CUSTOM INTERIOR CLADDING

METALWÄRKS® SERIES

ATAS International, Inc., a leader in the metal panel industry, has expanded its portfolio with the acquisition of the Metalwërks® line of architectural metal plate systems. Known for high-performance metal plate facades, integrated curtain wall components, and custom architectural features, Metalwërks enhances ATAS' ability to provide a comprehensive range of metal wall cladding solutions. This strategic move allows architects and designers to source single-skin panels, metal plate systems, insulated metal panels, and metal composite materials - all with matching finishes and the trusted quality of ATAS.

ATAS' Metalwërks® Series custom designs and fabricates panelized plate cladding for a variety of interior wall and ceiling applications to achieve an architect's vision and performance criteria. The smooth metal cladding may be applied to virtually any vertical, sloped, or horizontal surface over uninsulated masonry, structural steel, stud backup, or within curtain wall designs. An excellent choice for projects demanding wide design flexibility, the cladding accommodates artistic freedom by offering nearly unlimited combinations of finishes, profiles, and sizes, as well as options for joint treatments, all at a competitive value with other metal or non-metal cladding materials.

 www.metalwerksusa.com

FEATURES AND BENEFITS

- Typically manufactured in solid 0.063-0.125" aluminum
- Contains no plastic or insulation core materials
- Custom fabricated with no minimum production runs or size limitations
- Panels have uniform strength with no risk of delamination or combustion due to flammable components
- Welded panel corners, ground smooth with no visible seams
- All products are engineered and manufactured in-house
- Highly dent and puncture resistant, suitable for high-traffic or abusive environments
- Easily curved, contoured for radii down to 6"
- Post-applied finishing (applied after fabrication) by licensed applicators, producing the highest quality results
- Finish warranties up to 20 years (Consult factory for specific limitations)
- 100% recyclable panels manufactured from aluminum plate containing post-consumer and pre-consumer recycled content, which can contribute to LEED credits
- Available in no-VOC powder coat finishes
- Solid aluminum construction accommodates curves, 3D profiles, and difficult transitions without unsightly splices or joints common with composite materials
- Highly versatile due to formability for complex applications







GREEN CENTER WORKING



COLOR CHART





Stock Colors | 70% PVDF Finish

							
Black (02)	Classic Bronze (01)	Medium Bronze (03)	Hartford Green (27)	Forest Green (11)	Teal (19)	Hemlock Green (30)	Patina Green (12)
							
Chocolate Brown (04)	Boysenberry (25)	Redwood (07)	Mission Red (08)	Sierra Tan (09)	Rawhide (15)	Concord Cream (05)	Almond (36)
							
Sandstone (06)	Regal Blue (18)	Slate Blue (21)	Siam Blue (14)	Rocky Grey (16)	Charcoal Grey (62)	Slate Grey (20)	Dove Grey (13)
		For additional color & finish offerings, visit www.atas.com/colors . For current SRI values and agency listings refer to our Color and Reference Guide: www.atas.com/sri .					
Ascot White (10)	Bone White (26)						

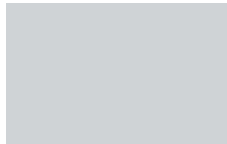

Matte Finish | 70% PVDF Finish

					
Matte Black (32)	Char Brown (29)	Thunder Grey (34)	Anchor Grey (37)	Ash Grey (33)	Almond (36)

Premium Colors | 70% PVDF Finish

					
Antique Patina (24)	Champagne (31)	Coppertone (23)	Titanium (35)	Silversmith (28)	Brite Red (17)

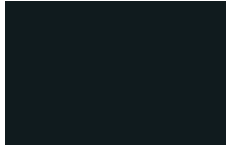
Anodized Aluminum

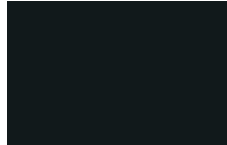
			
Clear Satin Anodized (70)	Dark Bronze Anodized (71)	BlackMatt Anodized (67)*	LA Extra Dark Bronze Anodized (66)*

Woodland Series | 70% PVDF Finish

				
Birch (57)	Cedar (54)	Driftwood (53)	Walnut (55)	Bamboo (81)

Oxide Series | 70% PVDF Finish

	
Tarnished Red (47)	Copper Brown (42)

ATAS International, Inc.

Allentown, PA | Mesa, AZ | University Park, IL | Elkton, MD
www.atas.com | 800.468.1441



*Subject to minimum quantities and extended lead time. Inquire for material and panel width availability. Wind-Lok® is a registered trademark of ATAS International, Inc. Colors are as close to the actual colors as modern printing allows. Exact color chips on request; this is a requirement for all premium colors. If you have requirements or preference for colors or finishes other than shown, contact ATAS. Color availability varies by material, gauge and profile. ATAS is not responsible for colors selected from color chart. ATAS reserves the right to modify, eliminate and/or change its products without prior notification. Contact ATAS for more information. Every project is different. To the full extent permissible by law, ATAS disclaims all warranties, express or implied, including, but not limited to, implied warranties of merchantability and fitness for a particular purpose. A qualified engineer, architect or contractor should review suitability of use. Please visit www.atas.com for the most up-to-date information. © 2026 ATAS International, Inc. LRD0326 LAT930