

Alternate Detail

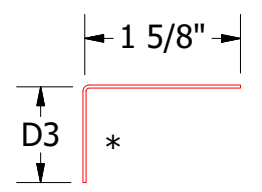

Angle Trim
DWA680: D3 = 1"
DSA680: D3 = 1 1/2"

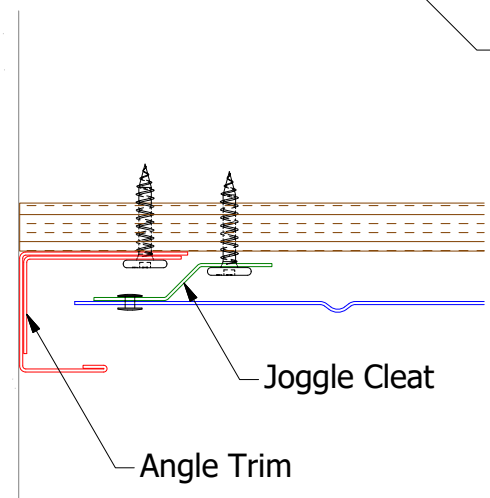
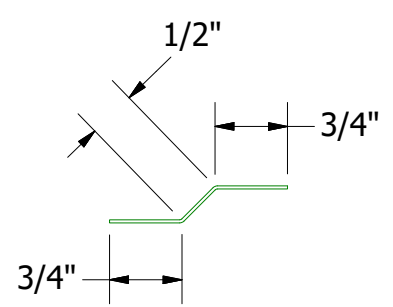

Joggle Cleat
DWA975
DSA975

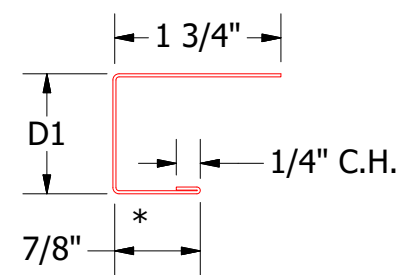

J Channel
DWA118: D1= 1 1/8"
DSA178: D1= 1 7/8"

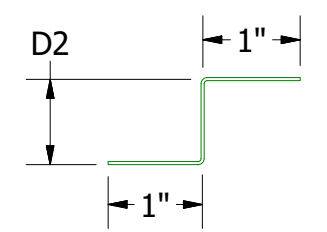

Support Z
DWA681: D2=1"
DSA681:D2=1 5/8"

Note: * denotes color side.

| | | | | | | | |
|----------|------------|------|---|-----|-----|--|-----------|
| REV. NO. | | DATE | DESCRIPTION OF REVISION | BY | APP | TITLE | |
| 01 | 10/27/2020 | | Revised Panel Assembly and Trim Dimensions. Added Alternate Detail | KRK | | Design Wall Ending Endwall Soffit Detail | |
| DWG. NO. | | | | | | DR | DATE |
| MATERIAL | | | | | | MBP | 7/11/2018 |
| | | | | | | APP | DATE |
| | | | | | | SH. SIZE | SCALE |
| | | | | | | B | X:X |

ATAS ATAS INTERNATIONAL, INC
Allentown PA
610-395-8445
Mesa AZ
480-558-7210

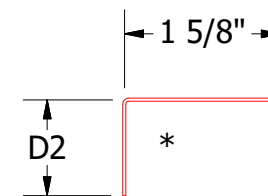
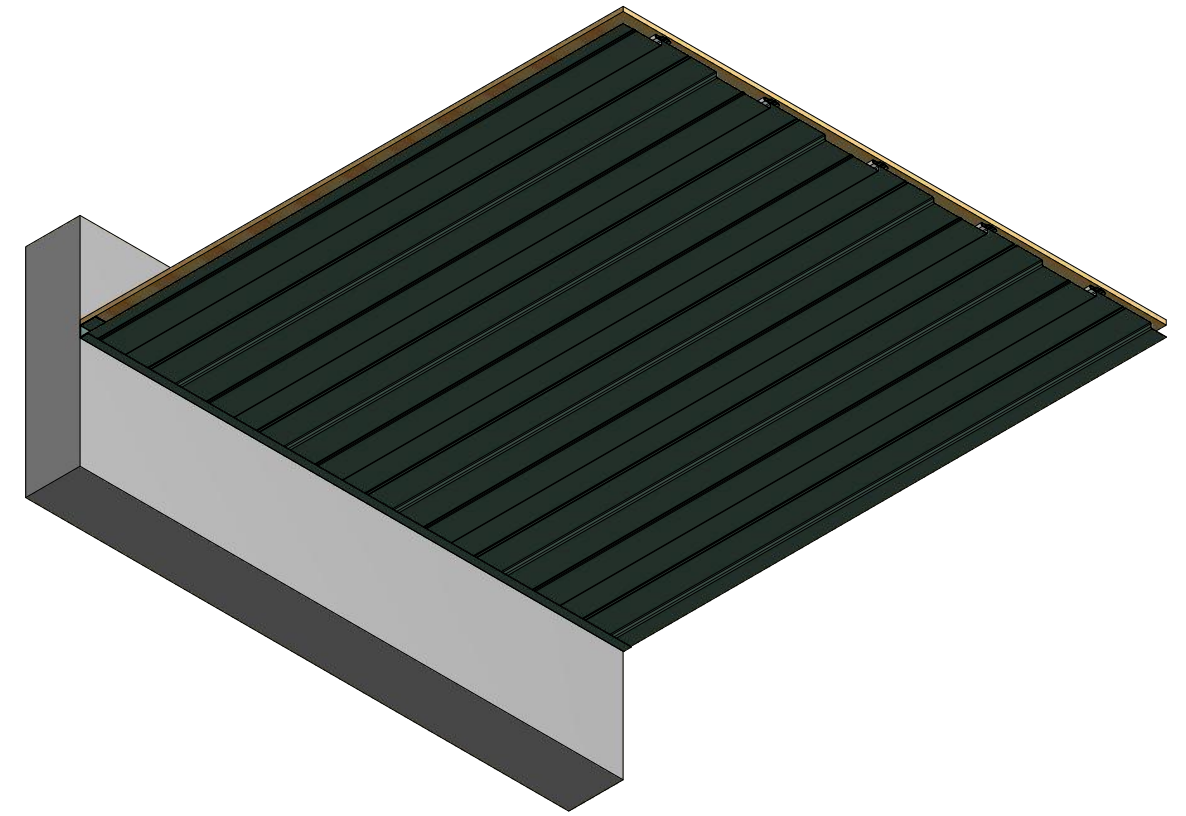
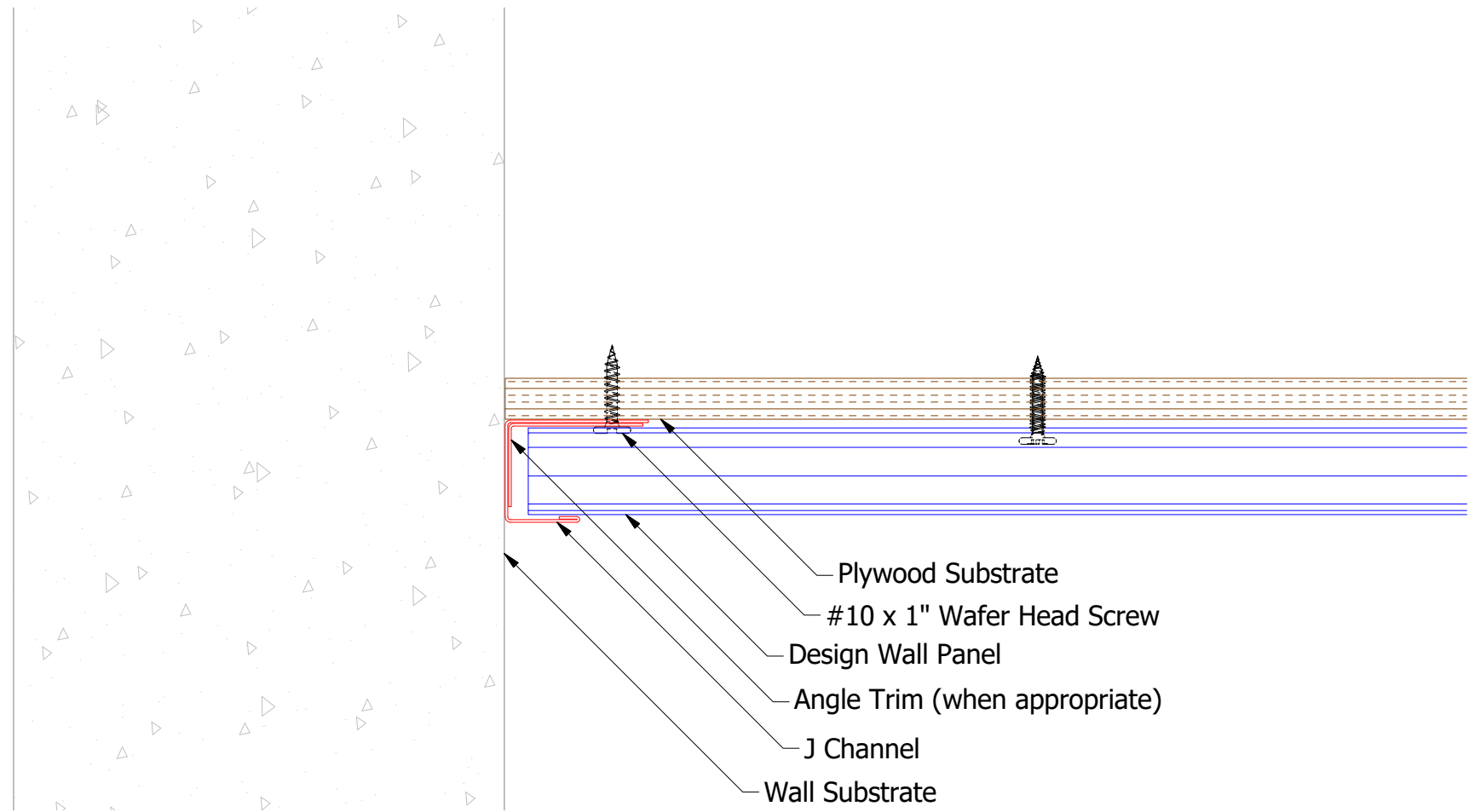

Angle Trim
 DWA680: D2 = 1"
 DSA680: D2 = 1 1/2"

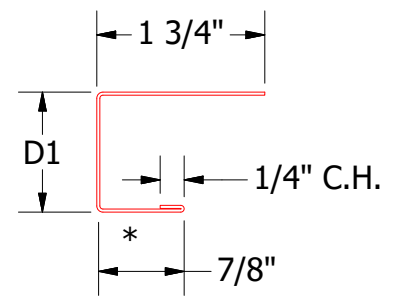

J Channel
 DWA118: D1= 1 1/8"
 DSA178: D1= 1 7/8"

ATAS INTERNATIONAL, INC
 Allentown PA
 610-395-8445
 Mesa AZ
 480-558-7210

| | | | | | | | |
|----------|------------|------|---|-------|-----|-----------------------------------|-------|
| | | | | TITLE | | Design Wall Endwall Soffit Detail | |
| REV. NO. | | DATE | DESCRIPTION OF REVISION | BY | APP | DWG. NO. | |
| 01 | 10/28/2020 | | Revised Panel Assembly and Trim Dimensions. | KRK | | DR | DATE |
| | | | | | | APP | DATE |
| | | | | | | SH. SIZE | SCALE |
| | | | | | | B | X:X |

DWH Design Wall Panels

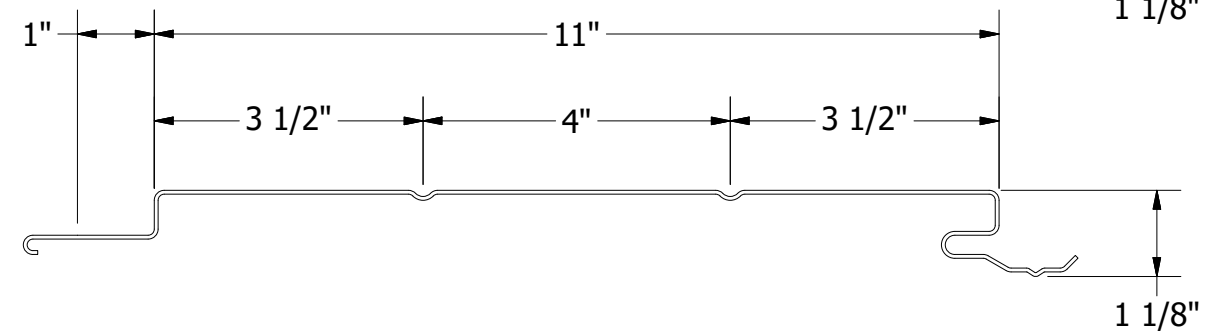
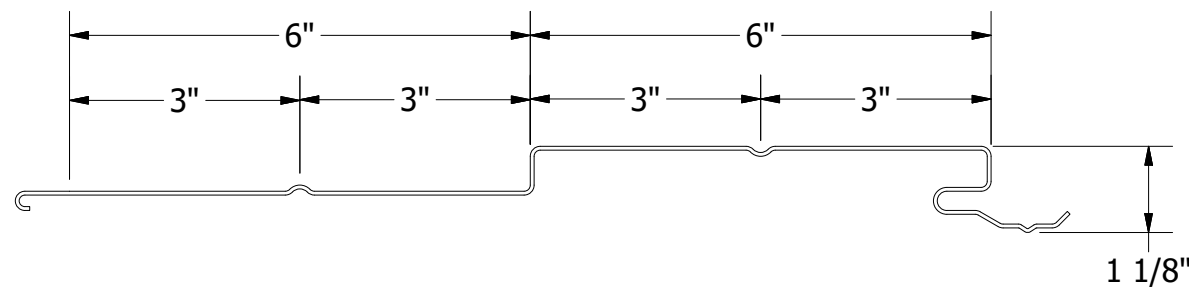
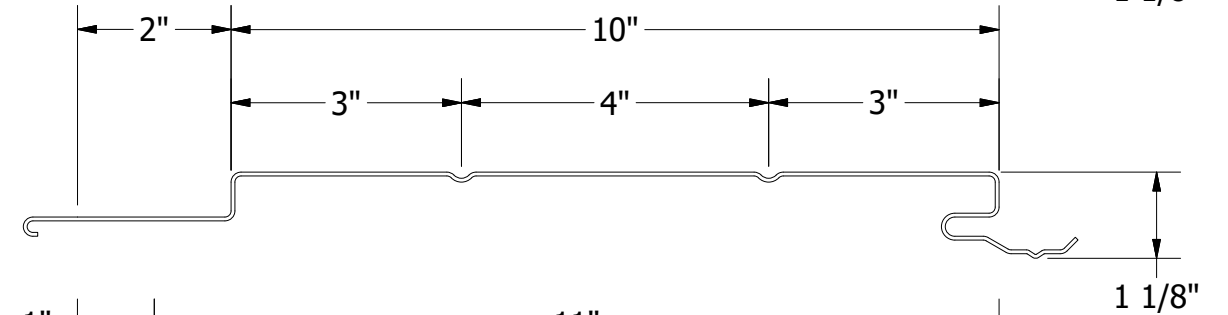
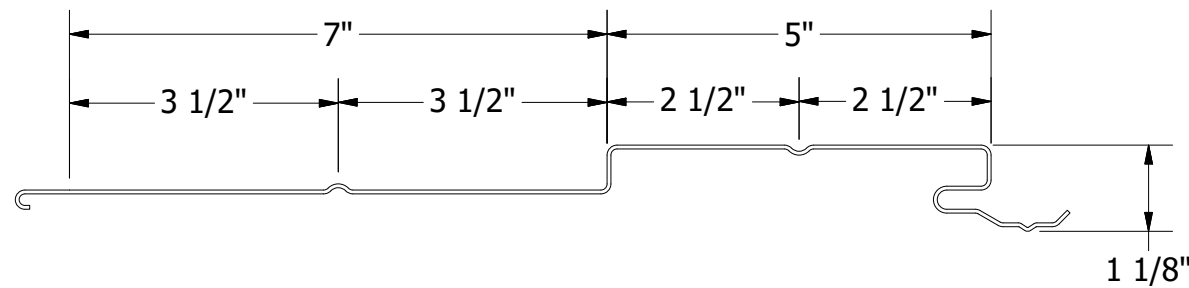
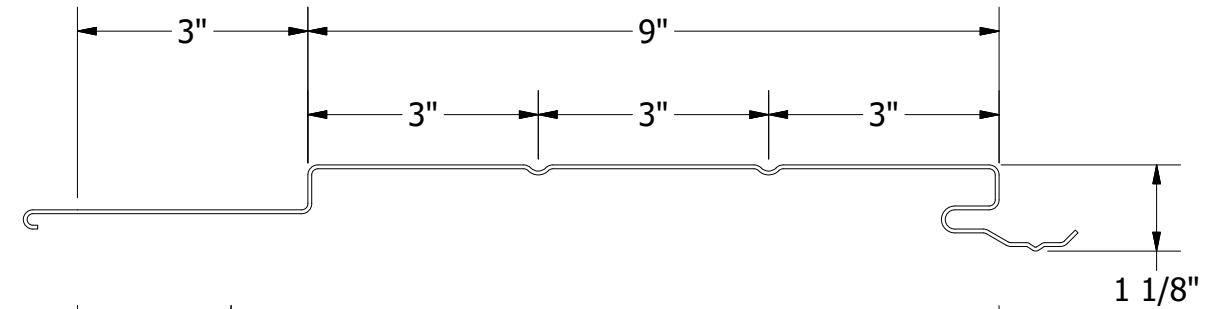
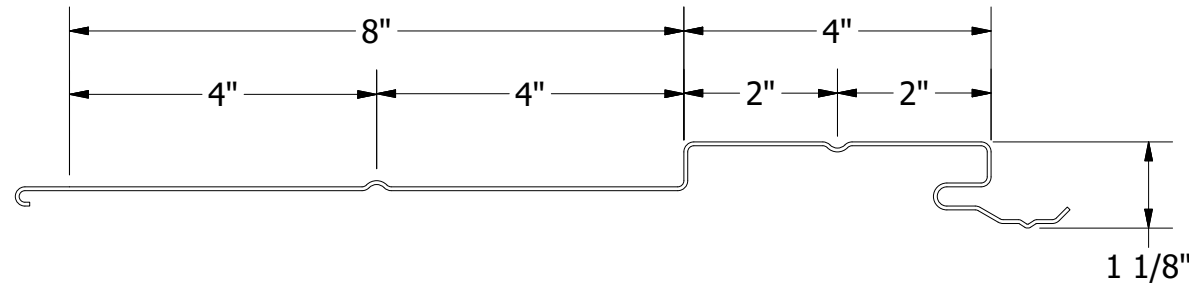
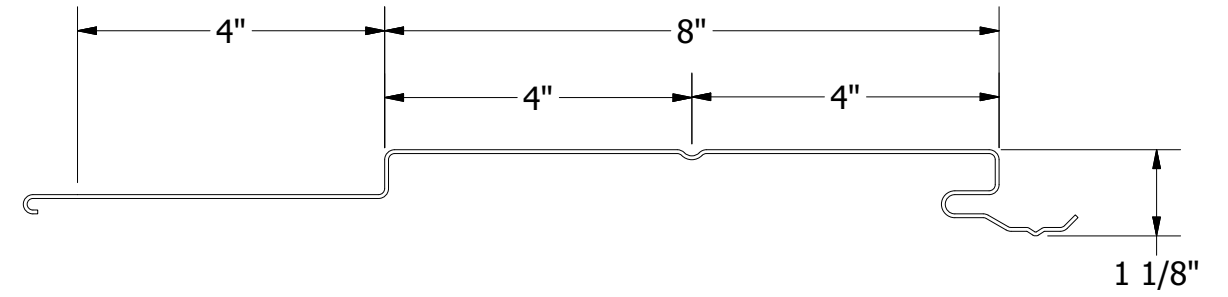
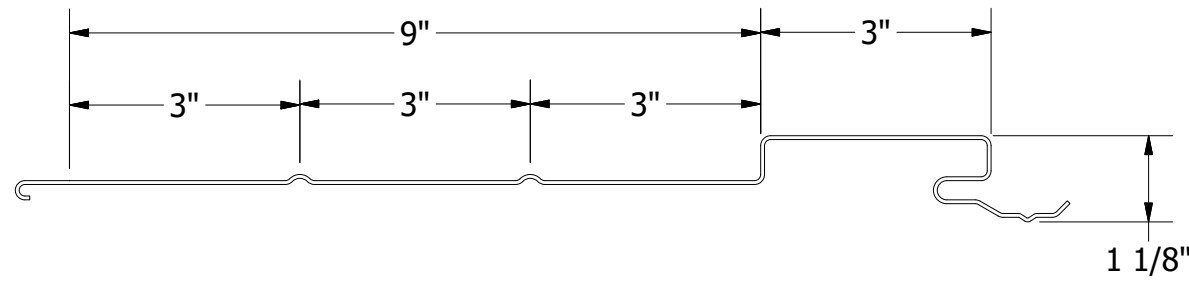
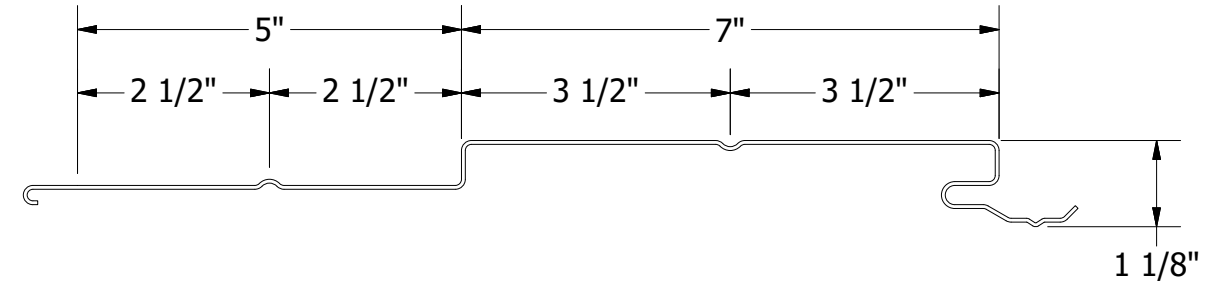
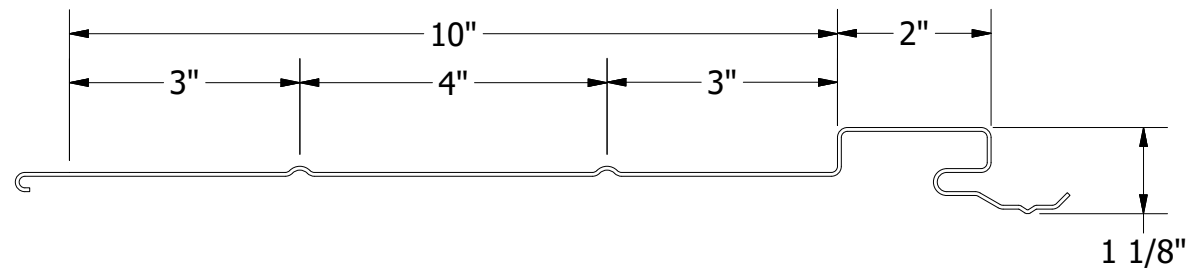

| | | | |
|----------|-----|------------------------------|----------|
| TITLE | | DWH, DSH Soffit Panel Detail | |
| DWG. NO. | DR | DATE | 6/6/2024 |
| | KRK | DATE | |
| MATERIAL | APP | SH. SIZE | B |
| | | SCALE | X:X |

| REV. NO. | DATE | DESCRIPTION OF REVISION | BY | APP |
|----------|------|-------------------------|----|-----|
| | | | | |
| | | | | |
| | | | | |

DSH Design Wall Panels

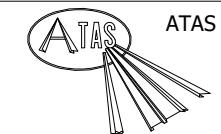
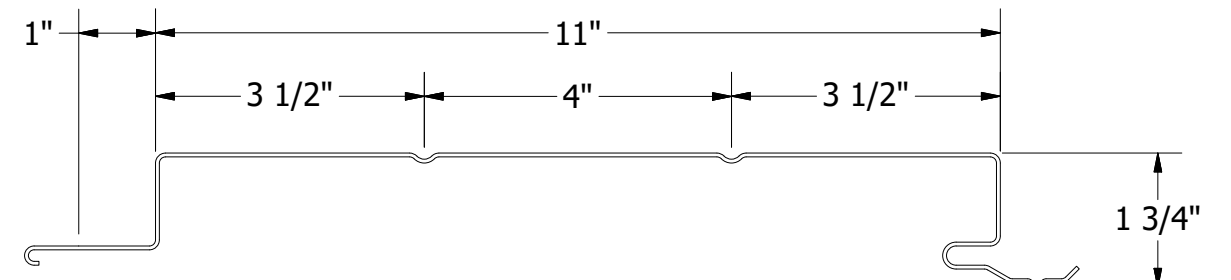
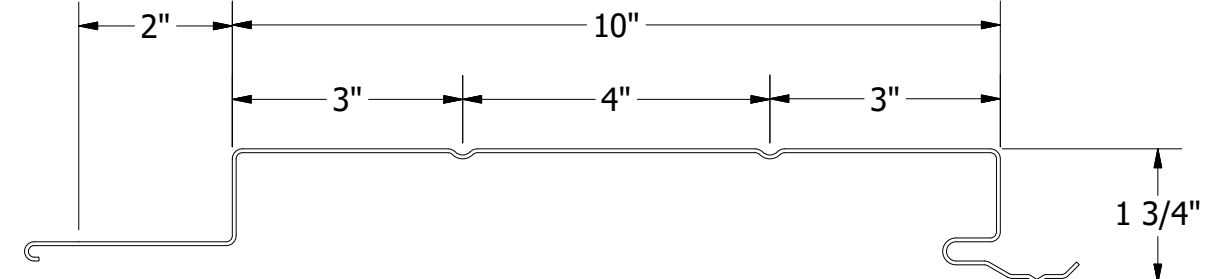
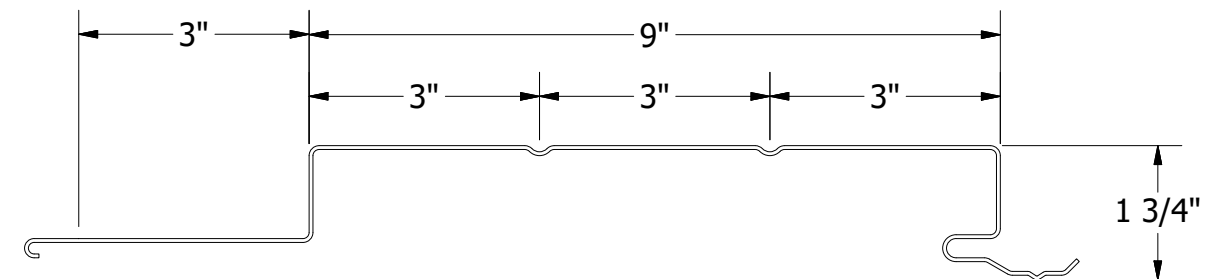
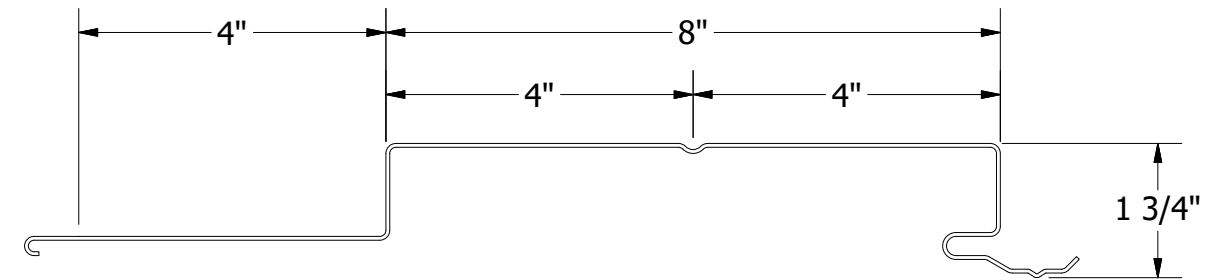
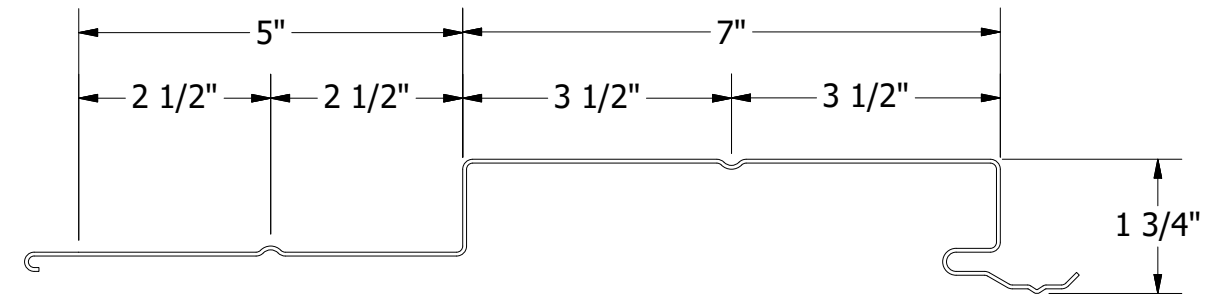
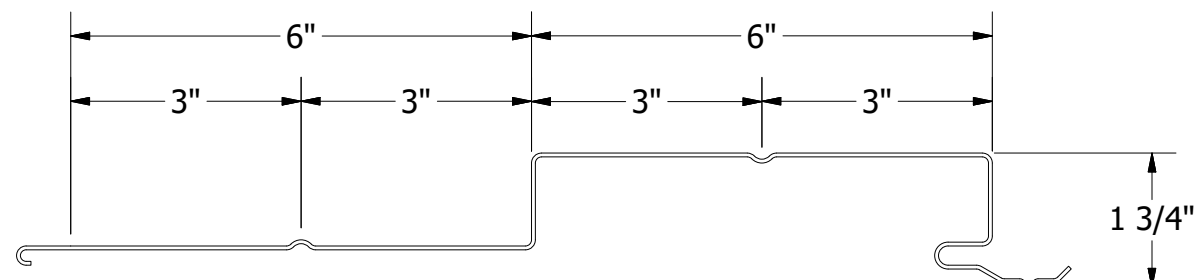
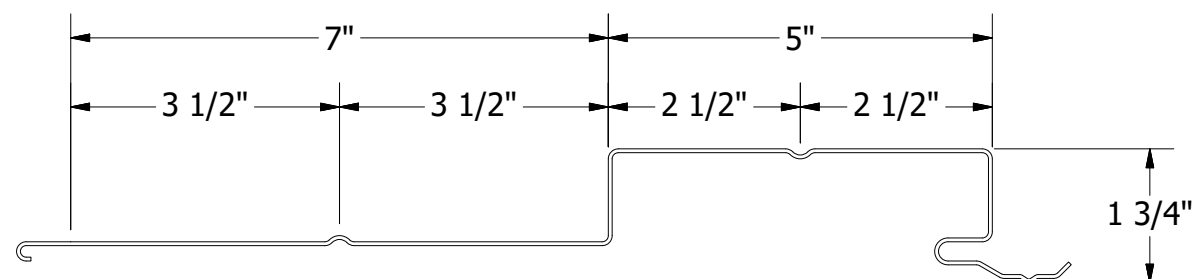
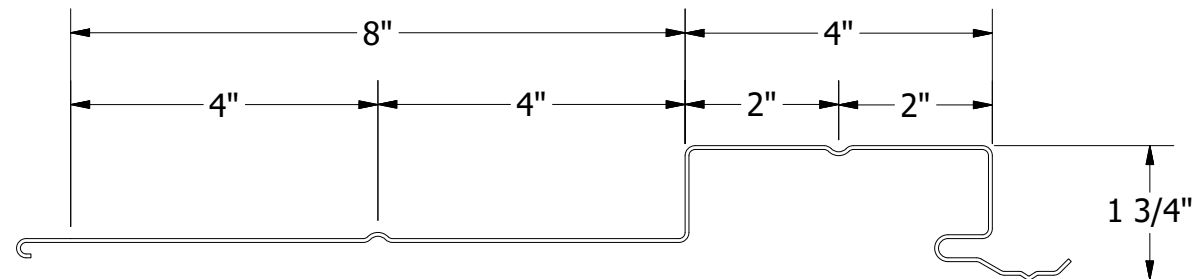
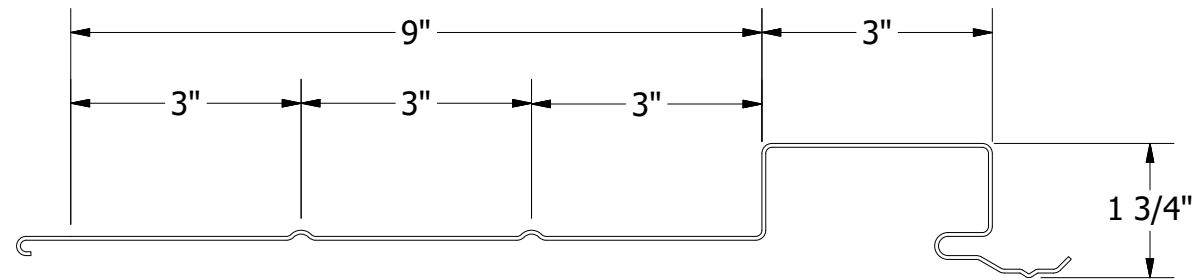
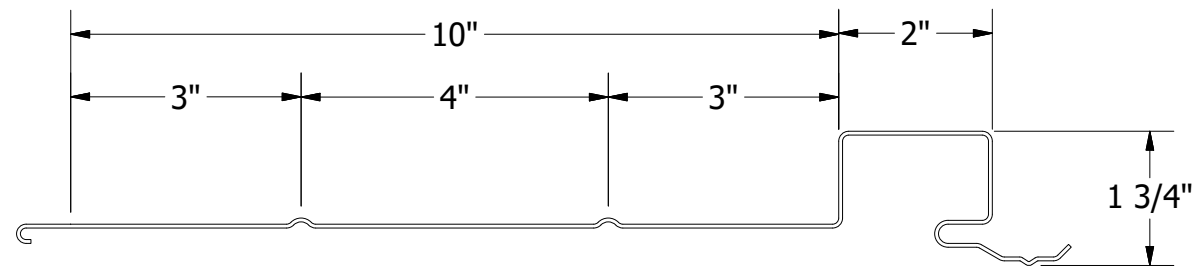

ATAS INTERNATIONAL, INC
 Allentown PA
 610-395-8445
 Mesa AZ
 480-558-7210

| | | | |
|----------|----------|------------------------------|-----------|
| TITLE | | DWH, DSH Soffit Panel Detail | |
| DWG. NO. | DR | DATE | 6/6/2024 |
| | KRK | | |
| MATERIAL | APP | DATE | |
| | SH. SIZE | B | SCALE X:X |

| REV. NO. | DATE | DESCRIPTION OF REVISION | BY | APP |
|----------|------|-------------------------|----|-----|
| | | | | |
| | | | | |
| | | | | |

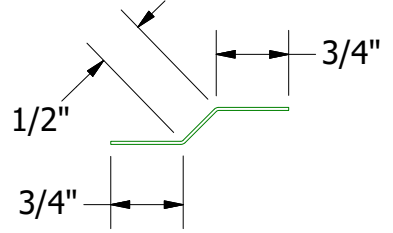
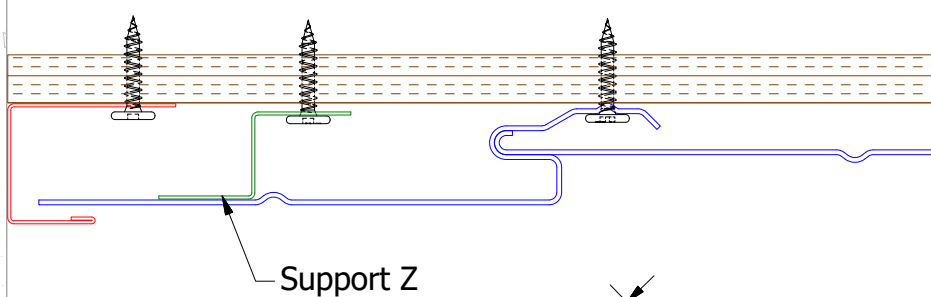
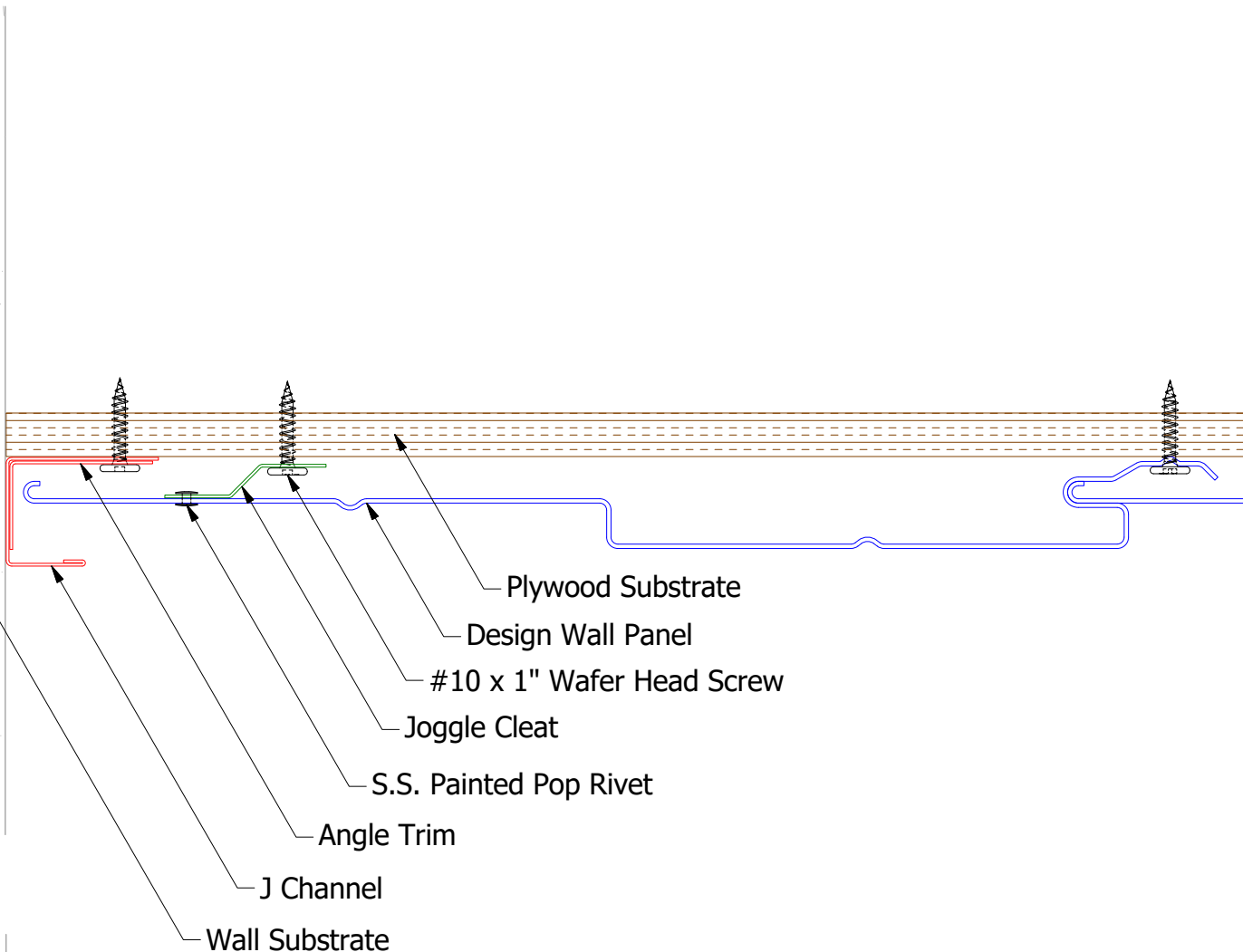

Joggle Cleat
DWA975
DSA975

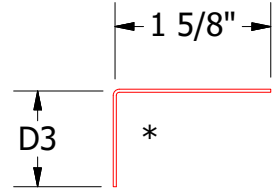

Angle Trim
DWA680: D3 = 1"
DSA680: D3 = 1 1/2"

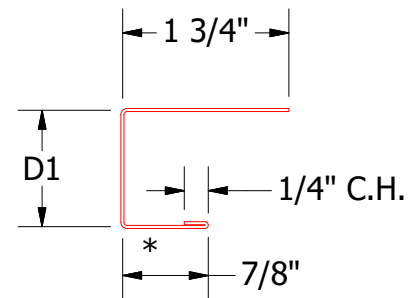
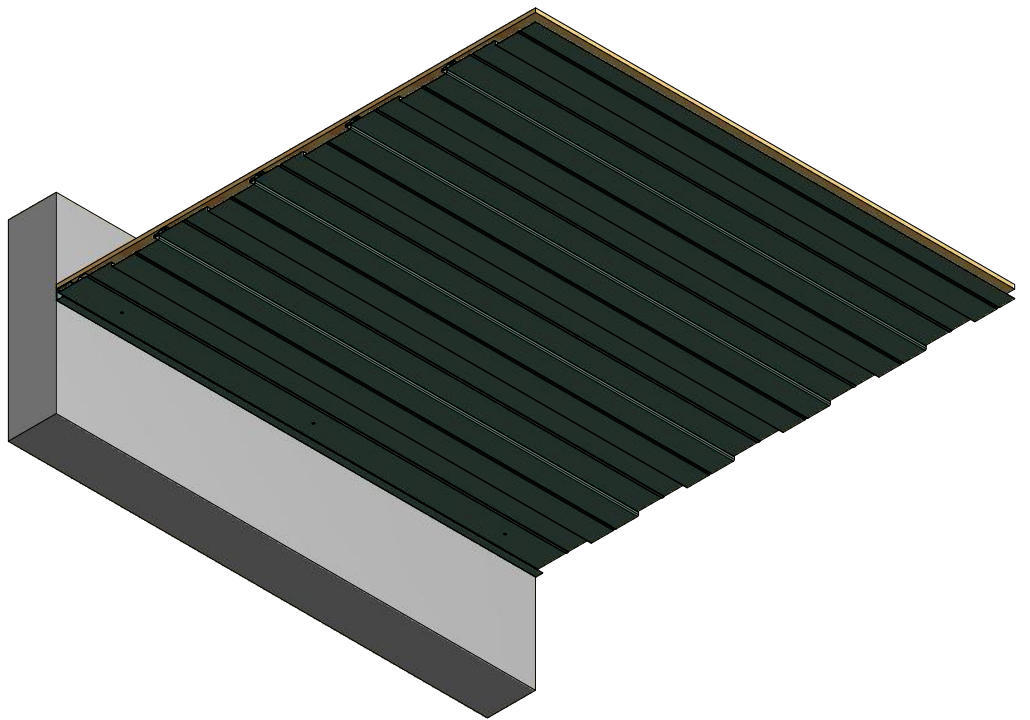

J Channel
DWA118: D1 = 1 1/8"
DSA178: D1 = 1 7/8"

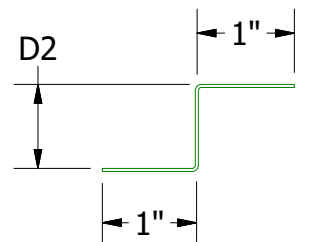

Support Z
DWA681: D2 = 1"
DSA681: D2 = 1 5/8"

Note: * denotes color side.

| | | | | | | | |
|----------|------------|------|--|-----|-----|--|-------|
| REV. NO. | | DATE | DESCRIPTION OF REVISION | BY | APP | TITLE | |
| 01 | 10/29/2020 | | Revised Panel Assembly and Trim Dimensions. Added Alternate Detail | KRK | | Design Wall Starting Endwall Soffit Detail | |
| | | | | | | DWG. NO. | DR |
| | | | | | | APP | DATE |
| | | | | | | SH. SIZE | SCALE |
| | | | | | | B | X:X |

ATAS ATAS INTERNATIONAL, INC
Allentown PA
610-395-8445
Mesa AZ
480-558-7210

| | |
|-------|-----------|
| DATE | 7/12/2018 |
| DATE | |
| SCALE | X:X |

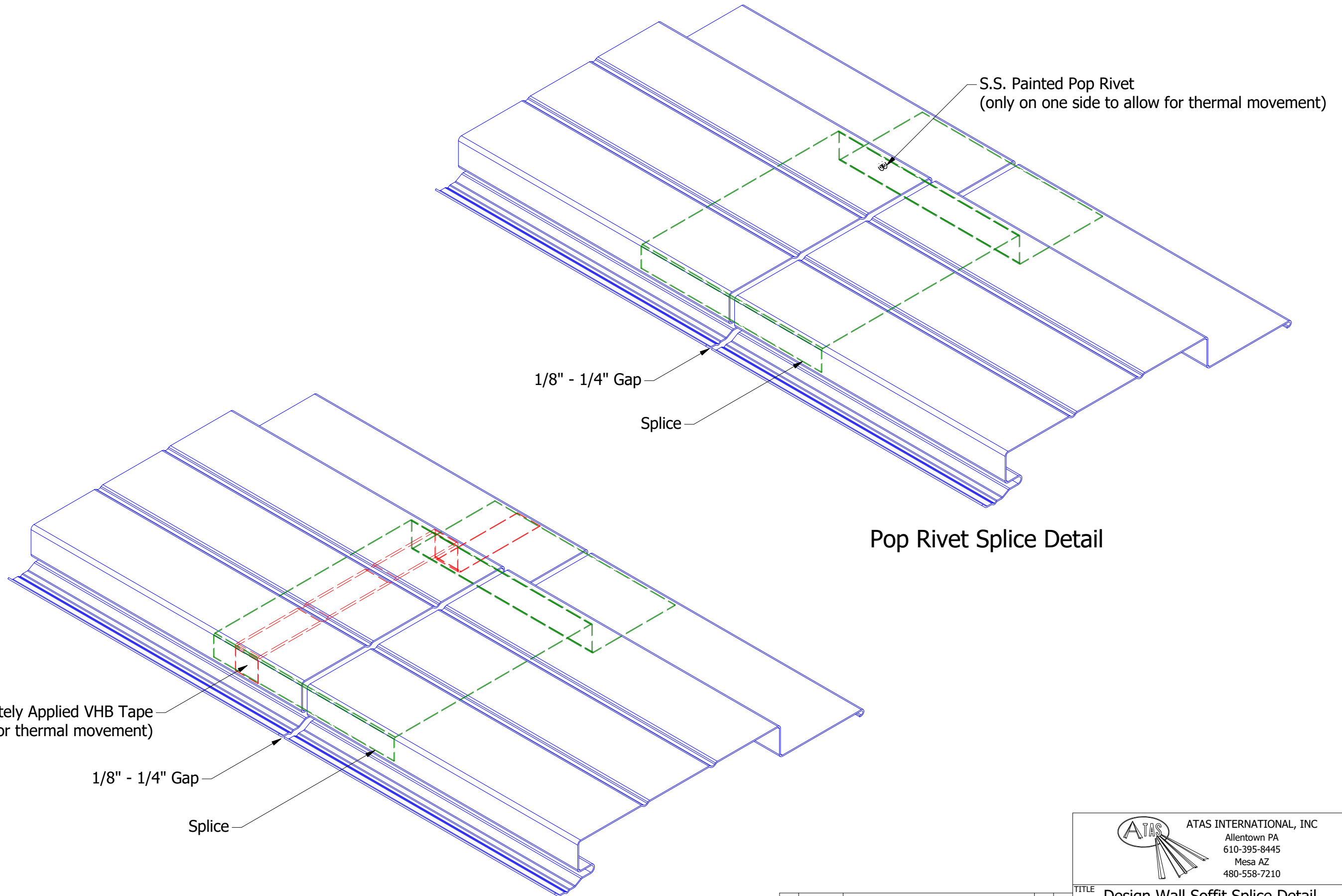

Pop Rivet Splice Detail

VHB Tape Splice Detail

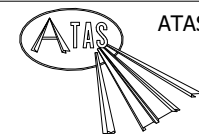

ATAS INTERNATIONAL, INC
 Allentown PA
 610-395-8445
 Mesa AZ
 480-558-7210

| | | | | | |
|----------|--|-----|----------------------------------|------|-----------|
| TITLE | | | Design Wall Soffit Splice Detail | | |
| DWG. NO. | | DR | KRK | DATE | 6/11/2024 |
| | | APP | | DATE | |
| MATERIAL | | | SH. SIZE | B | SCALE |
| | | | | | X:X |

| REV. NO. | DATE | DESCRIPTION OF REVISION | BY | APP |
|----------|------|-------------------------|----|-----|
| | | | | |
| | | | | |
| | | | | |