

**MFF120**

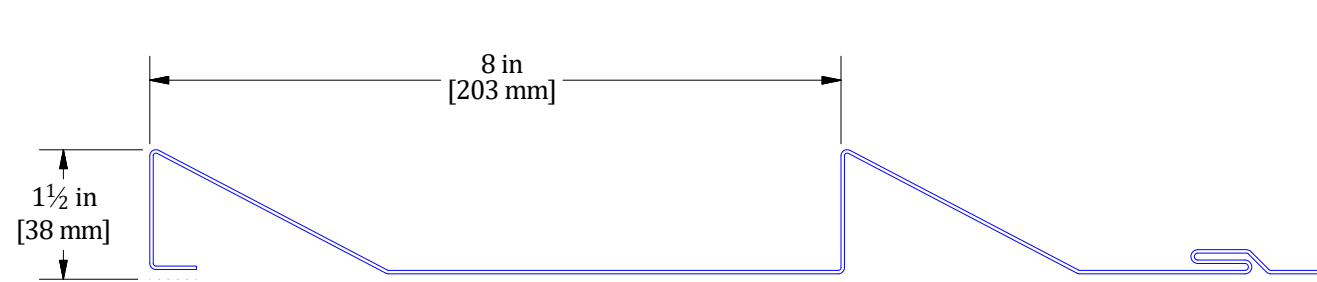

**MFF121**

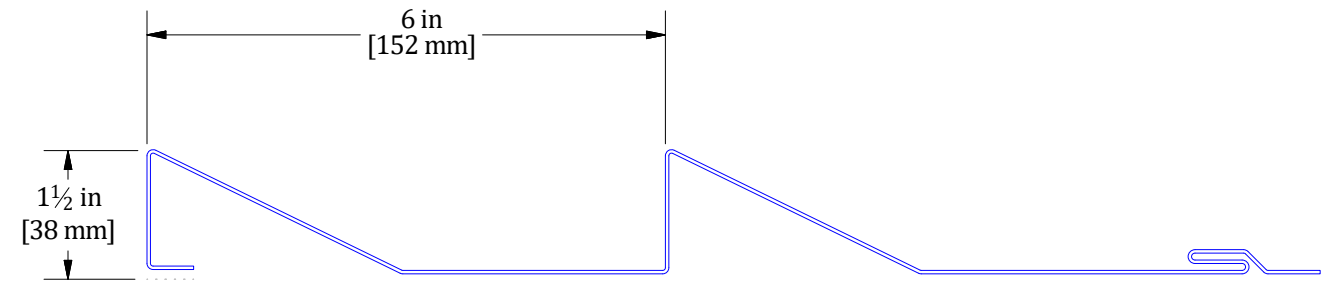

**MFF123**

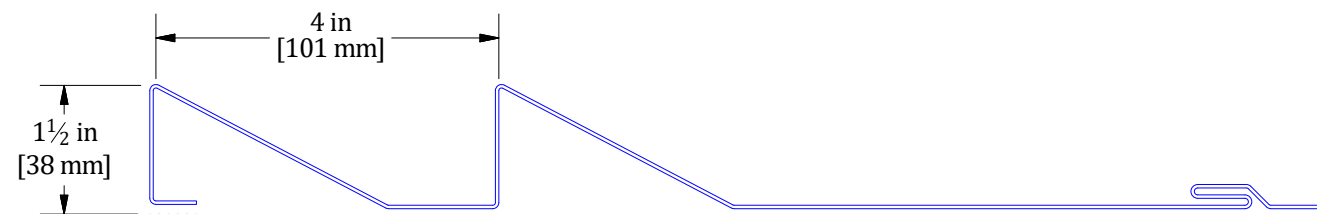

**MFF122**



**MFF124**

**Notes:**



DWG TITLE:		Panel Profiles	
DWG No:		DWG BY:	M.L.P.
		DWG DATE:	4/30/2026
APP BY:	D.S.	APP DATE:	4/30/2026
PANELS/PRODUCT:	(MFF) MultiFin	SHEET SIZE:	B
		SCALE:	X : X

REV. NO.	DATE	DESCRIPTION OF REVISION	BY	APP
0	4/30/2026	Initial Release	M.L.P.	D.S.

# Vertical Panel

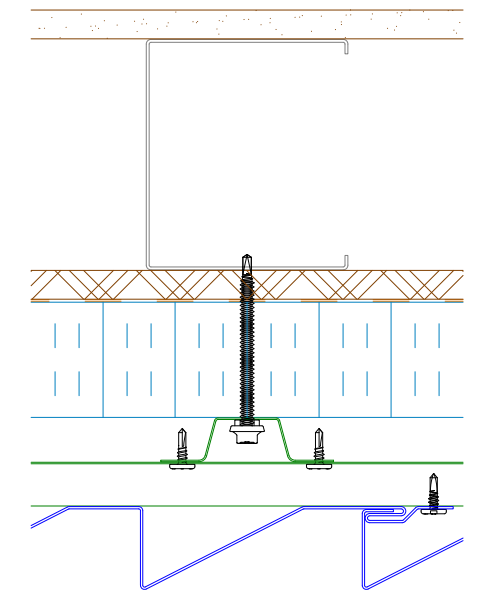
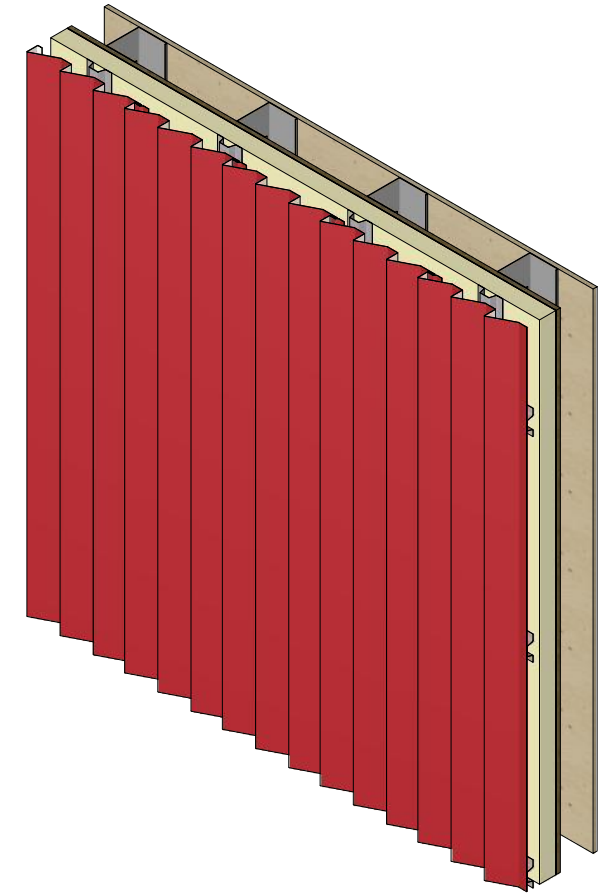
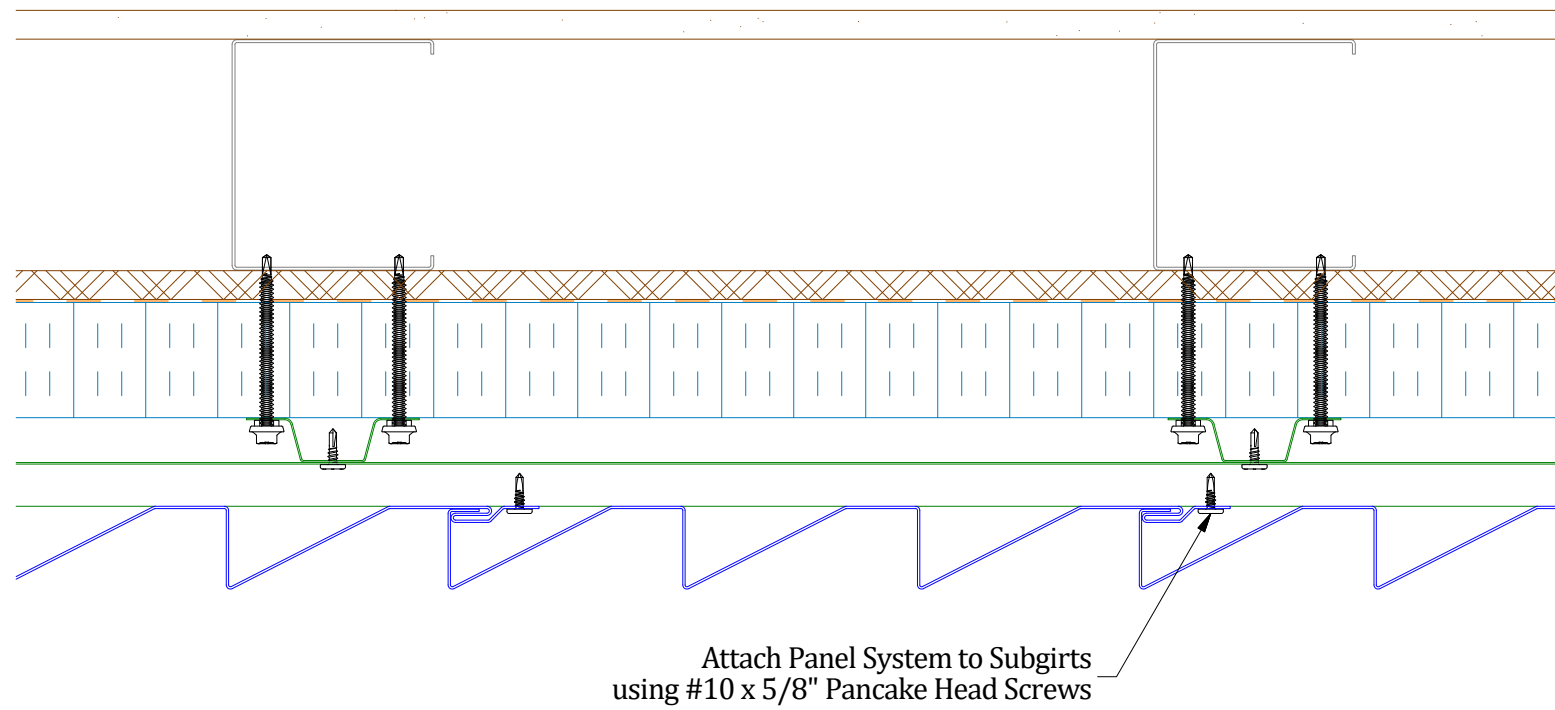
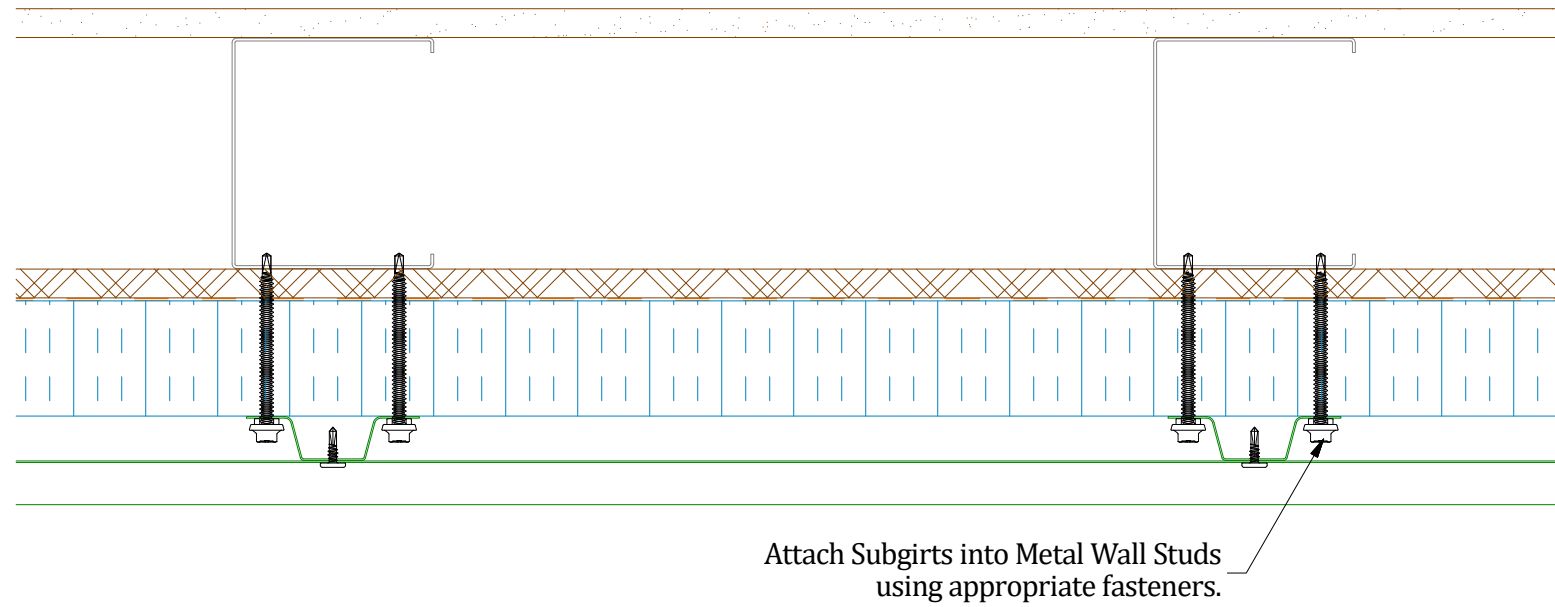
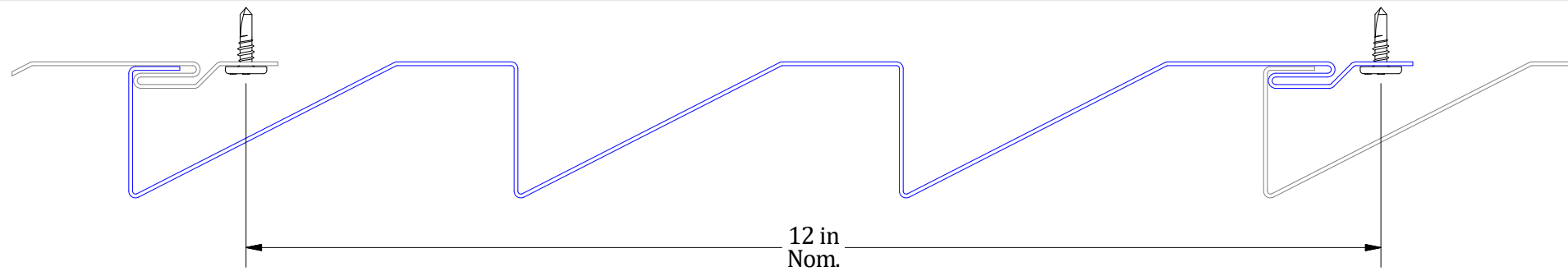

Alternative Subgirt Orientation

## Notes:

**ATAS International, Inc.**  
 Sustainable Solutions For A Better Future  
 www.atas.com | info@atas.com  
 800.468.1441

DWG TITLE: <b>Open Framing Installation Detail</b>	
DWG No.:	DWG DATE: 5/1/2026
APP BY: M.L.P.	APP DATE: 5/1/2026
PANELS/PRODUCT: (MFF) MultiFin	
SHEET SIZE: B	SCALE: X : X

REV. NO.	DATE	DESCRIPTION OF REVISION	BY	APP
0	5/1/2026	Initial Release	M.L.P.	D.S.

Secure Fastener in Center of the Slot  
 Field Pre-Punch Fastener Slots to allow for Panel Expansion and Contraction

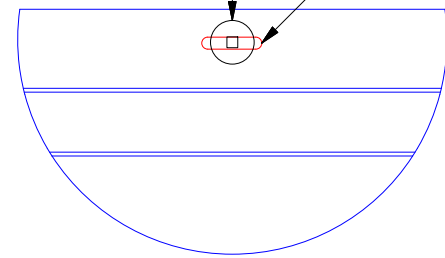

**DETAIL A**

Pin Panel in Center (x3)

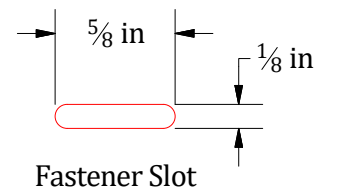
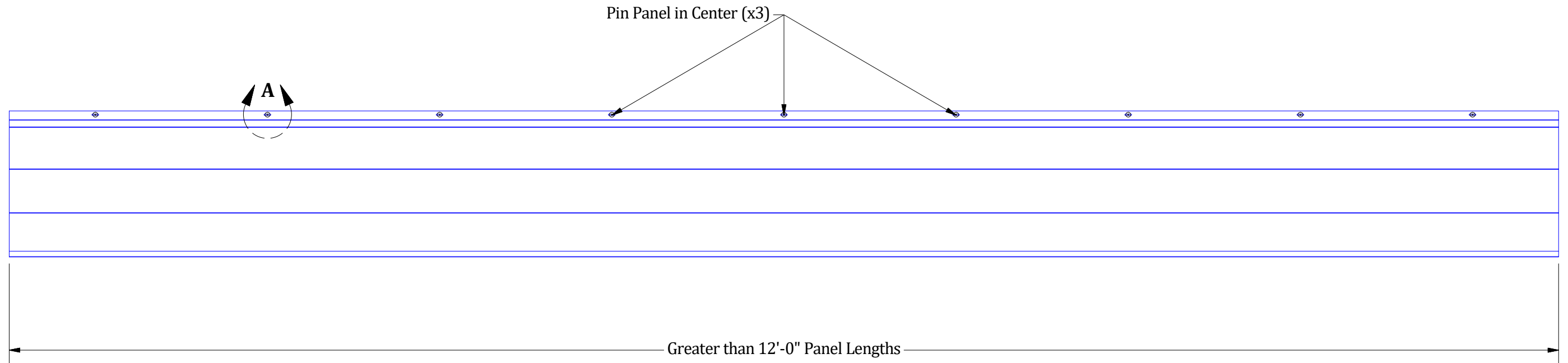

**Notes:**

**ATAS** **ATAS International, Inc.**  
 Sustainable Solutions For A Better Future  
 www.atas.com | info@atas.com  
 800.468.1441

REV. NO.		DATE	DESCRIPTION OF REVISION	BY	APP	DWG TITLE: <b>Panel Fastening Slot Detail</b>	
0	4/30/2026	Initial Release		M.L.P.	D.S.	DWG No.	
						PANELS/PRODUCT:	<b>(MFF) MultiFin</b>
						DWG BY:	M.L.P.
						APP BY:	D.S.
						DWG DATE:	4/30/2026
						APP DATE:	4/30/2026
						SHEET SIZE:	B
						SCALE:	X : X

# Vertical Panel

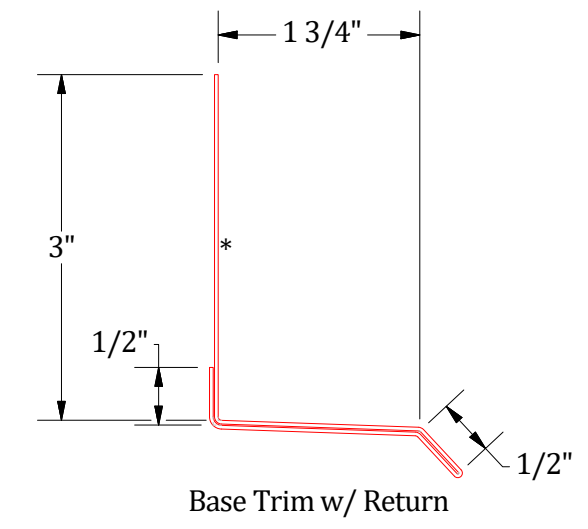
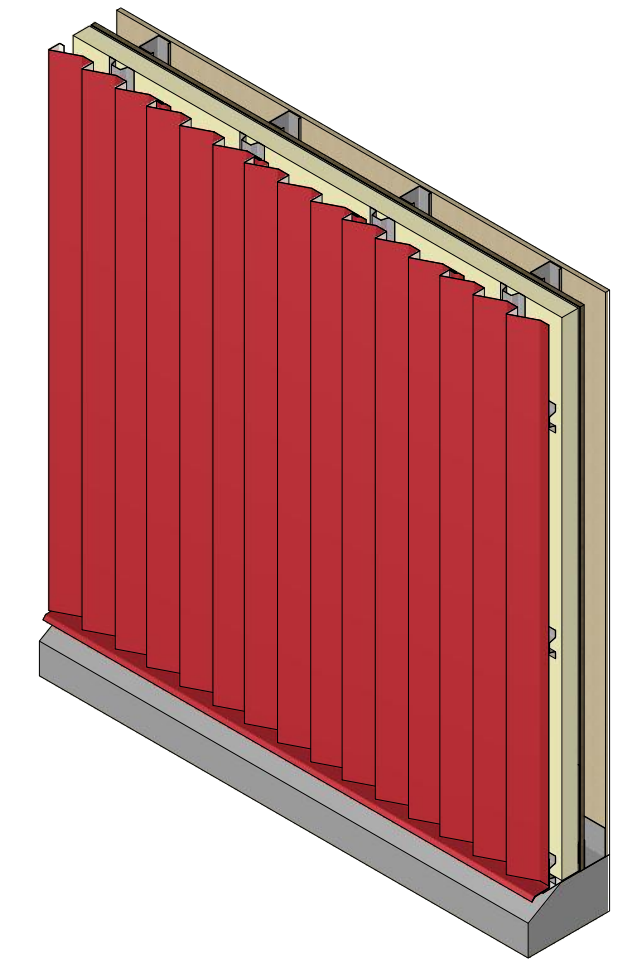
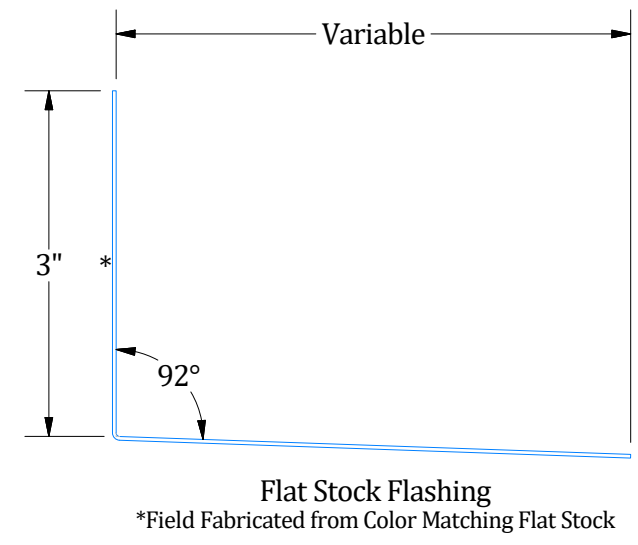
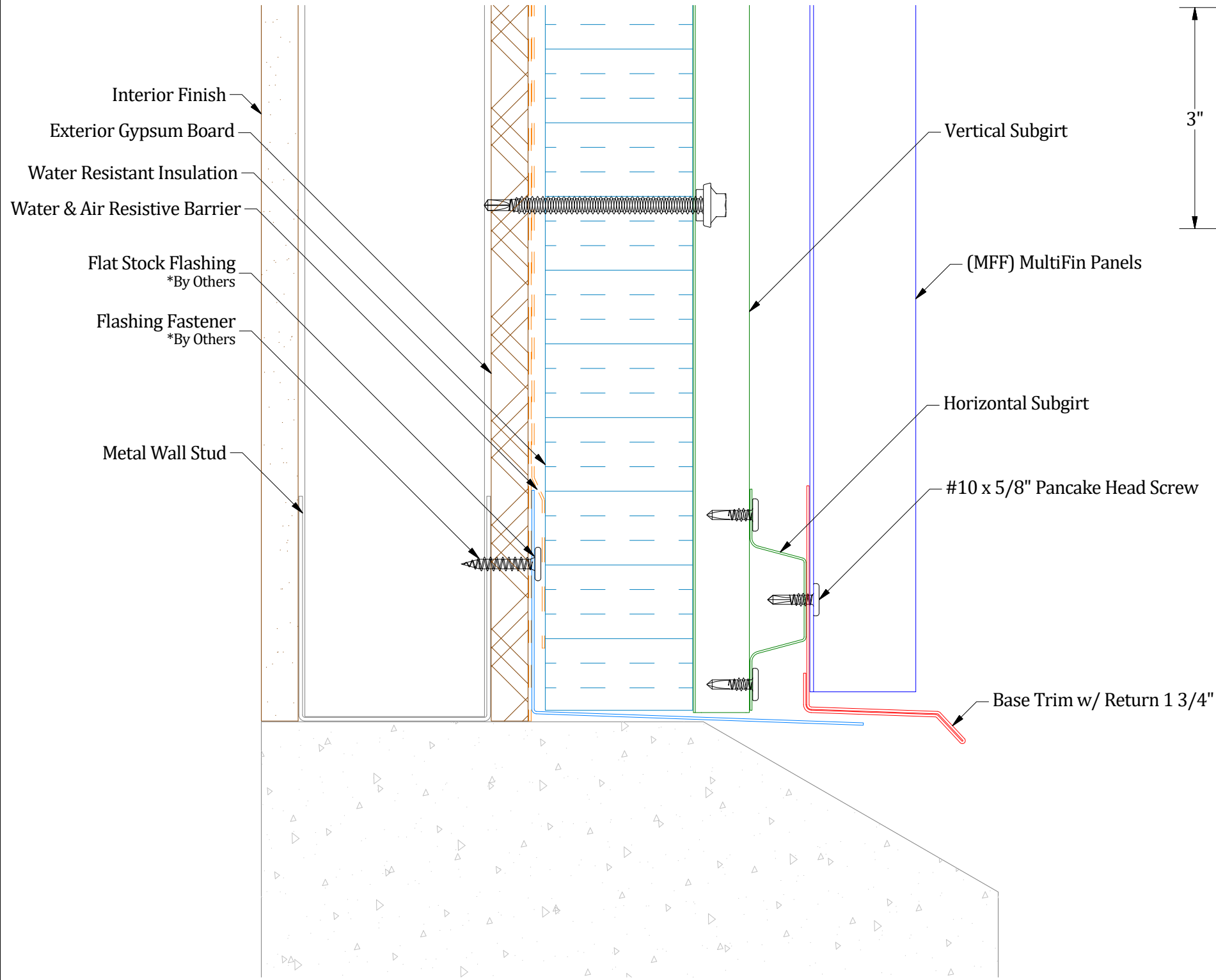

**Notes:**  
1) \* denotes color side.

**ATAS International, Inc.**  
Sustainable Solutions For A Better Future  
www.atas.com | info@atas.com  
800.468.1441

DWG TITLE: <b>Open Framing Base Detail</b>		DWG No.:		DWG BY: M.L.P.	DWG DATE: 5/1/2026
REV. NO.:		DATE:	DESCRIPTION OF REVISION:	BY:	APP:
0	5/1/2026	Initial Release		M.L.P.	D.S.
PANELS/PRODUCT: <b>(MFF) MultiFin</b>				APP BY: D.S.	APP DATE: 5/1/2026
				SHEET SIZE: B	SCALE: X : X

# Vertical Panel

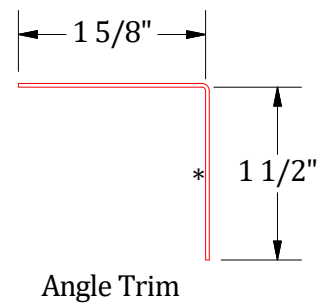
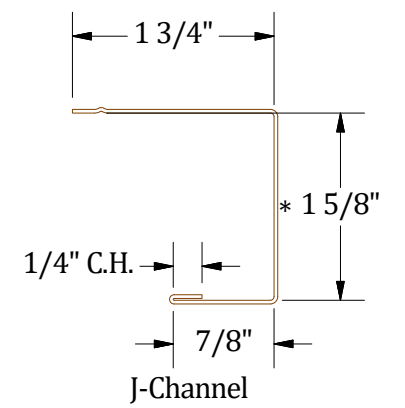
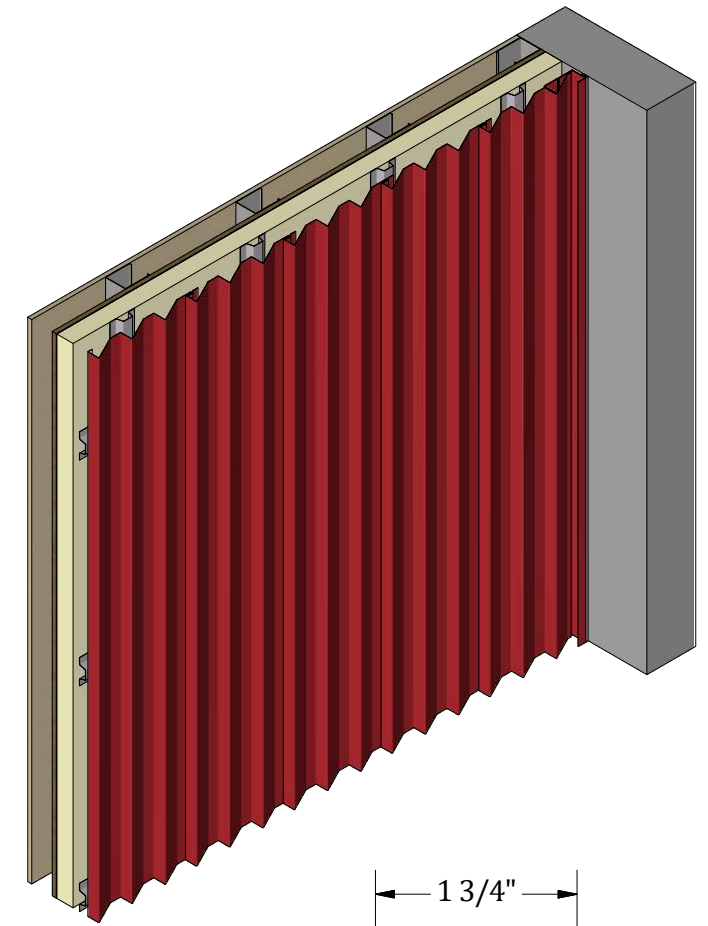
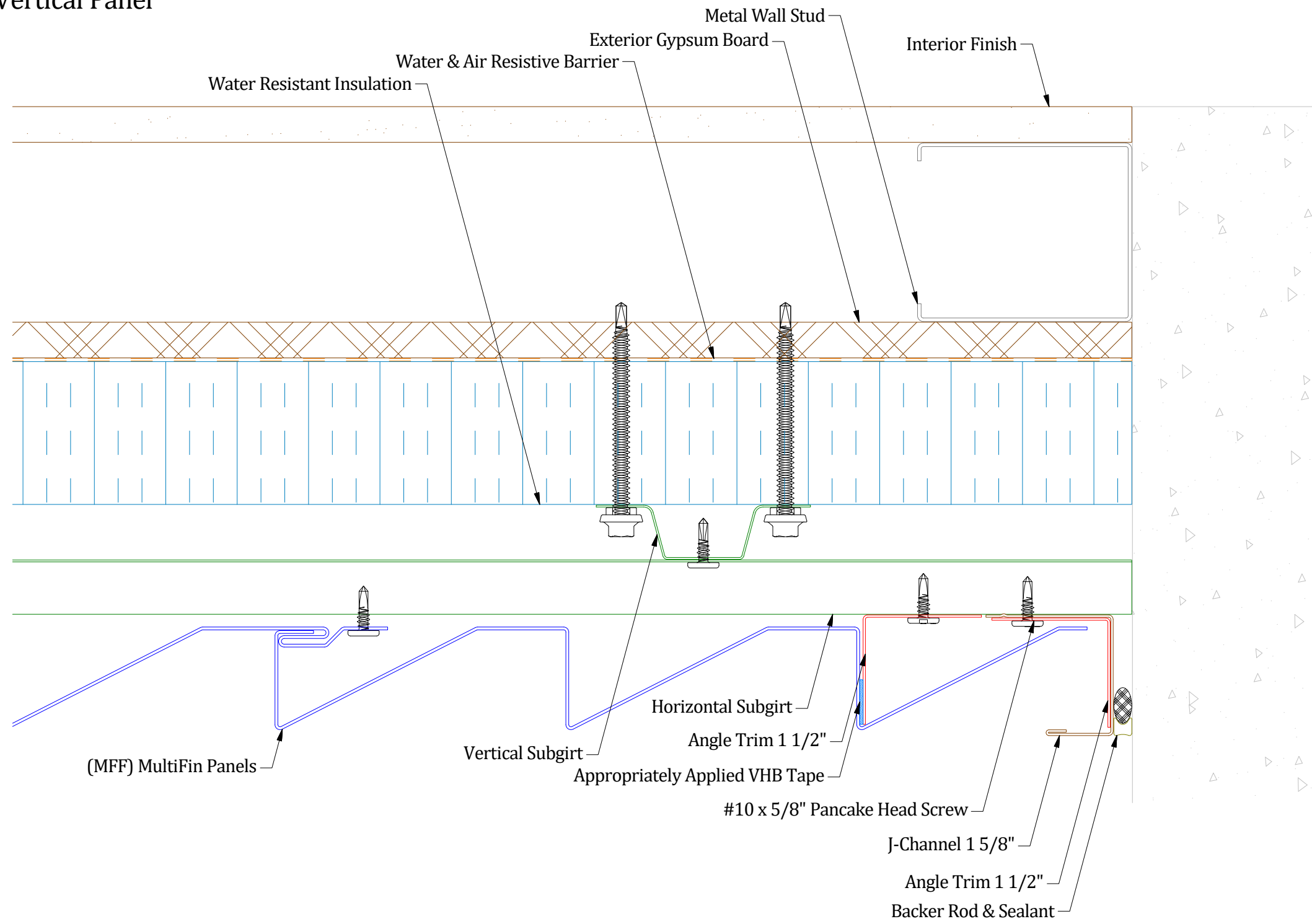

## Notes:

1) \* denotes color side.

**ATAS International, Inc.**  
 Sustainable Solutions For A Better Future  
 www.atas.com | info@atas.com  
 800.468.1441

REV. NO.	DATE	DESCRIPTION OF REVISION	BY	APP	DWG. No.	DWG. DATE	DWG. TITLE
0	5/1/2026	Initial Release	M.L.P.	D.S.		5/1/2026	Open Framing Endwall Detail
					PANELS/PRODUCT:		(MFF) MutliFin
					DWG. BY:	M.L.P.	
					APP. BY:	D.S.	
					SHEET SIZE:	B	
					SCALE:	X : X	

# Vertical Panel

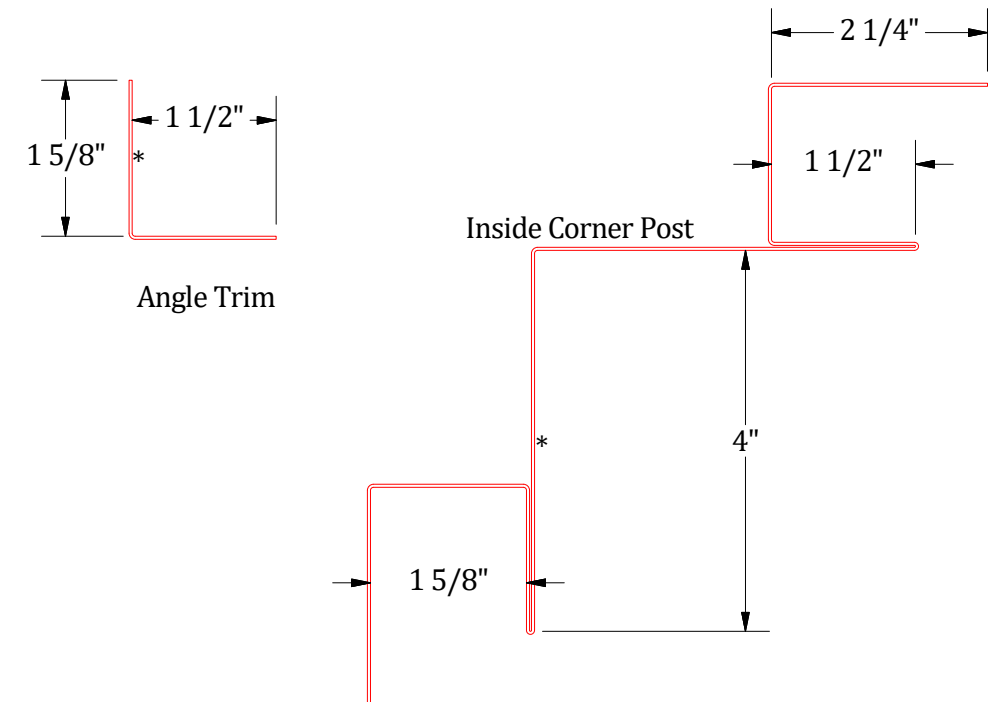
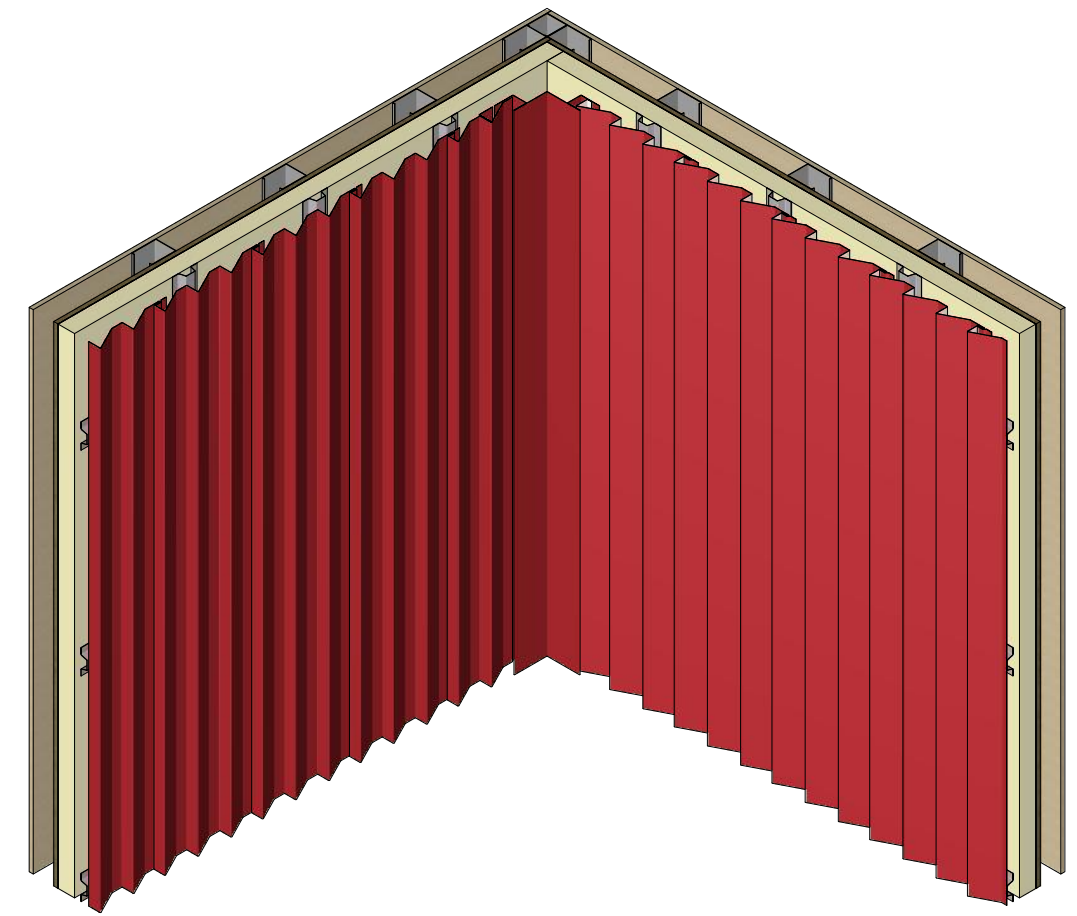
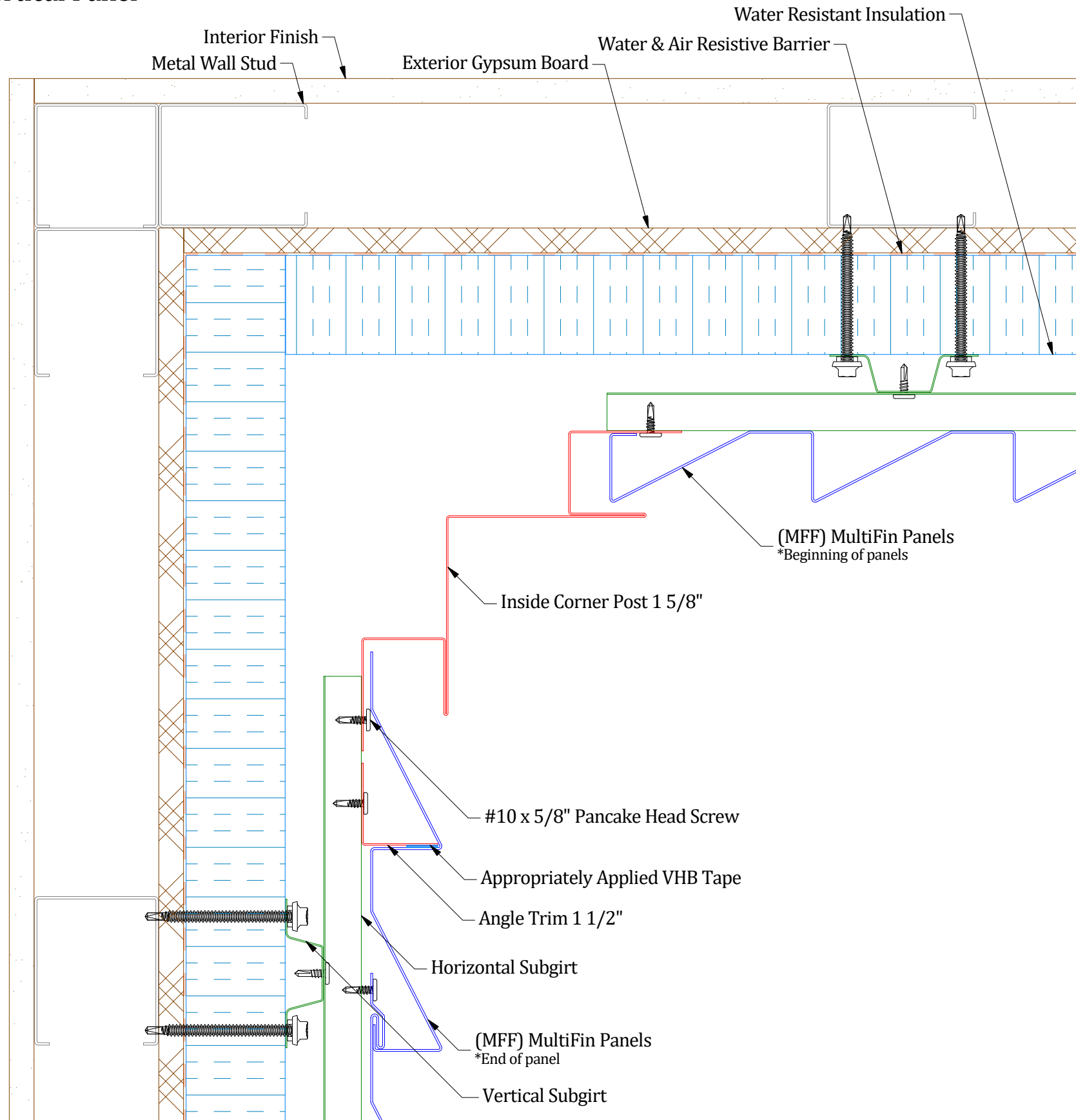

**Notes:**  
1) \* denotes color side.

**ATAS International, Inc.**  
Sustainable Solutions For A Better Future  
www.atas.com | info@atas.com  
800.468.1441

REV. NO.	DATE	DESCRIPTION OF REVISION	BY	APP	PANELS/PRODUCT:	DWG No.	DWG DATE:	APP BY:	APP DATE:	SHEET SIZE:	SCALE:
0	5/1/2026	Initial Release	M.L.P.	D.S.	(MFF) MutliFin		5/1/2026	D.S.	5/1/2026	B	X : X

# Vertical Panel

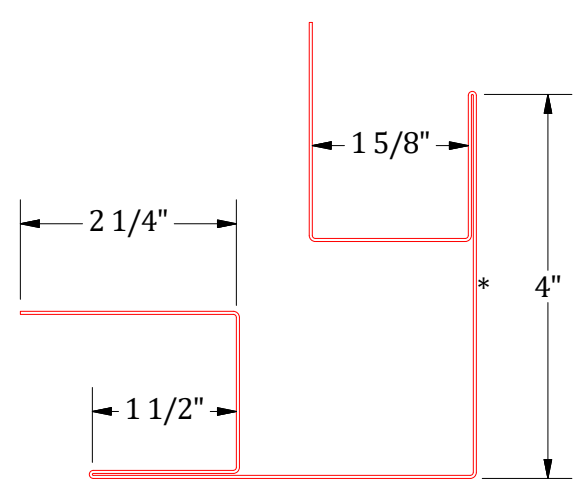
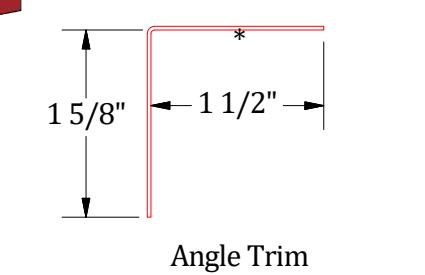
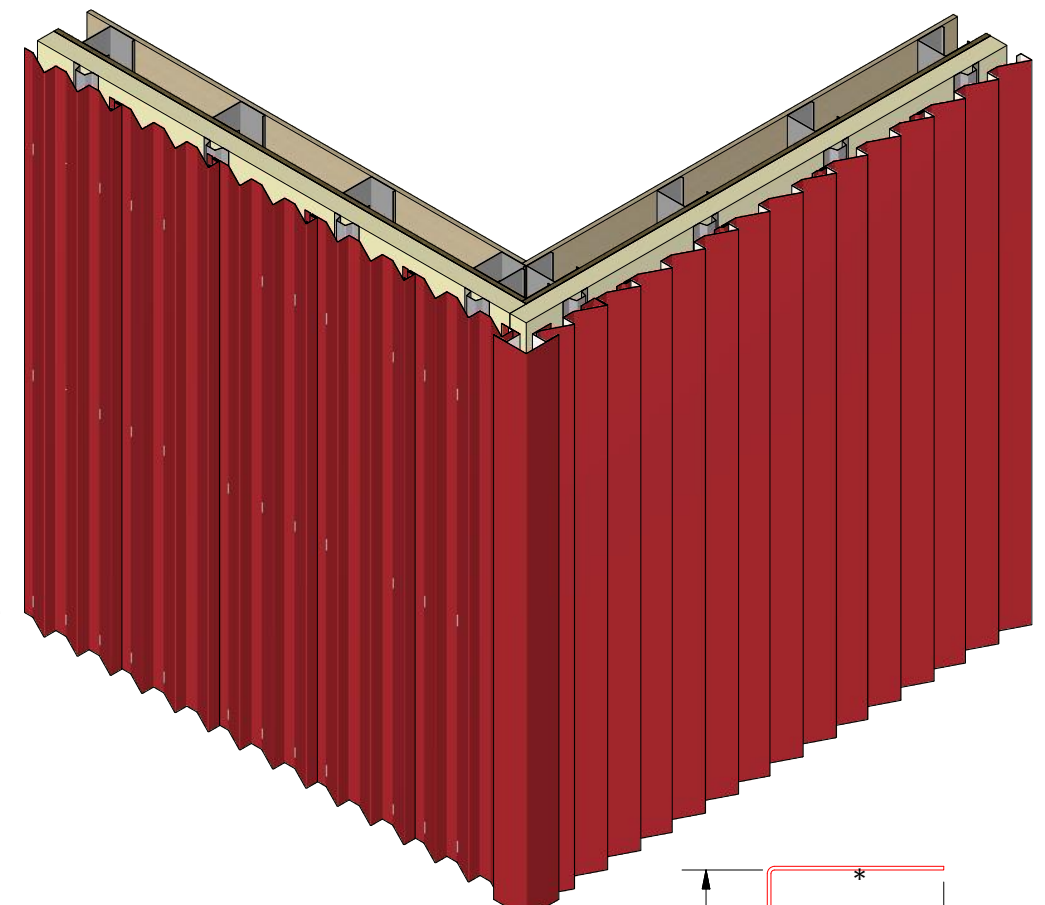
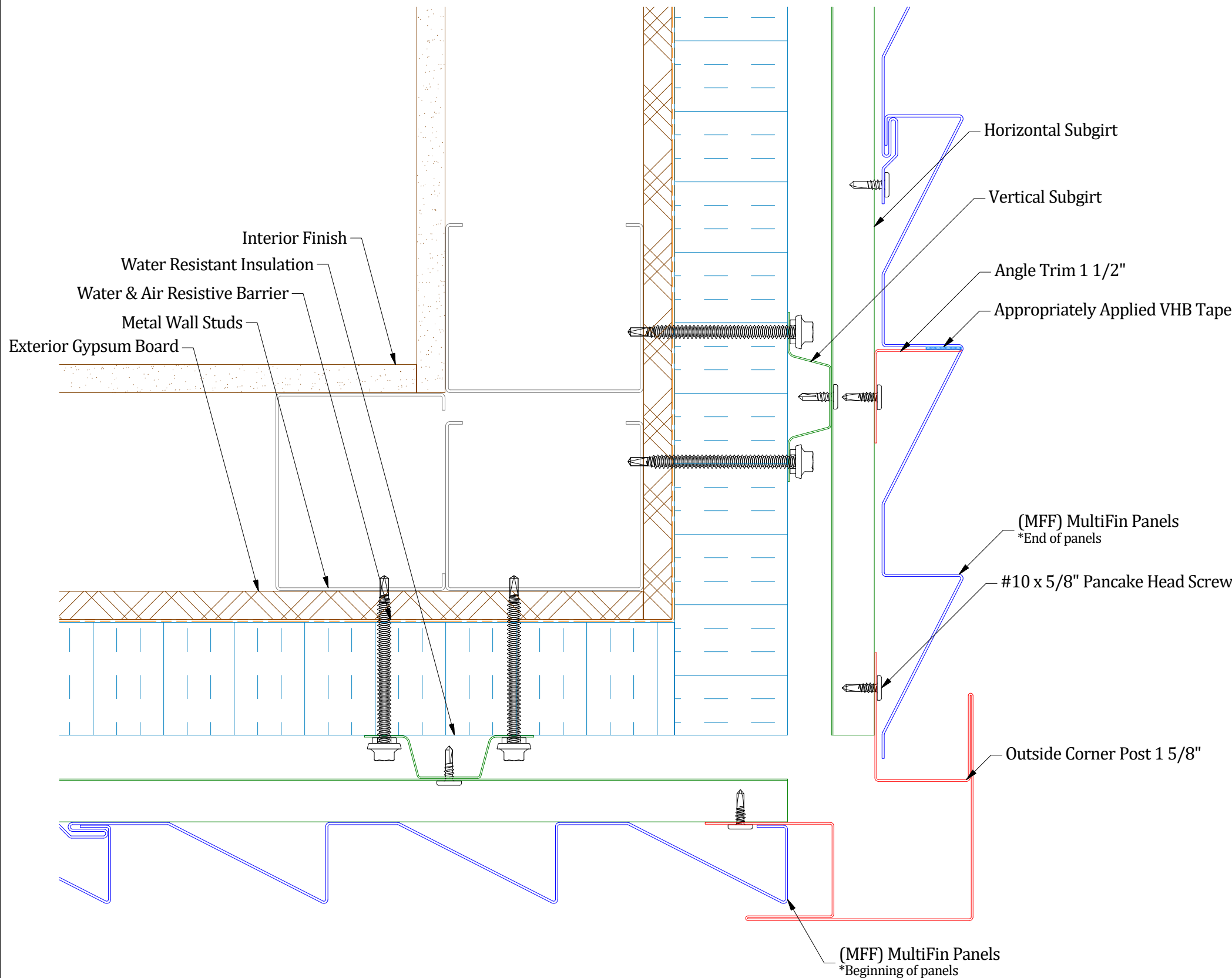

**Notes:**  
1) \* denotes color side.

**ATAS International, Inc.**  
Sustainable Solutions For A Better Future  
www.atas.com | info@atas.com  
800.468.1441

REV. NO.	DATE	DESCRIPTION OF REVISION	BY	APP	PANELS/PRODUCT:	DWG TITLE:	DWG No:	DWG DATE:	APP BY:	APP DATE:	SHEET SIZE:	SCALE:
0	5/1/2026	Initial Release	M.L.P.	D.S.	(MFF) MultiFin	Open Framing Outside Corner Post Detail		5/1/2026	D.S.	5/1/2026	B	X : X

# Vertical Panel

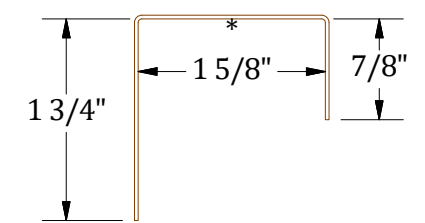
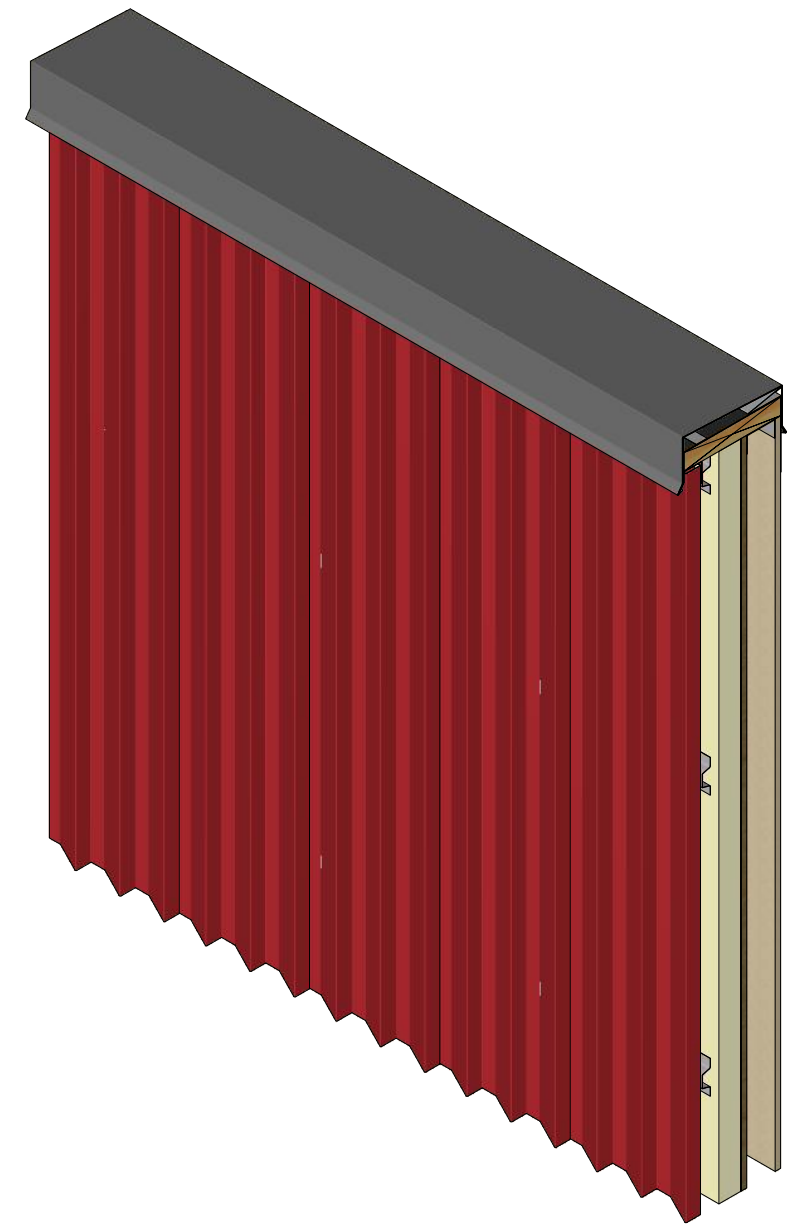
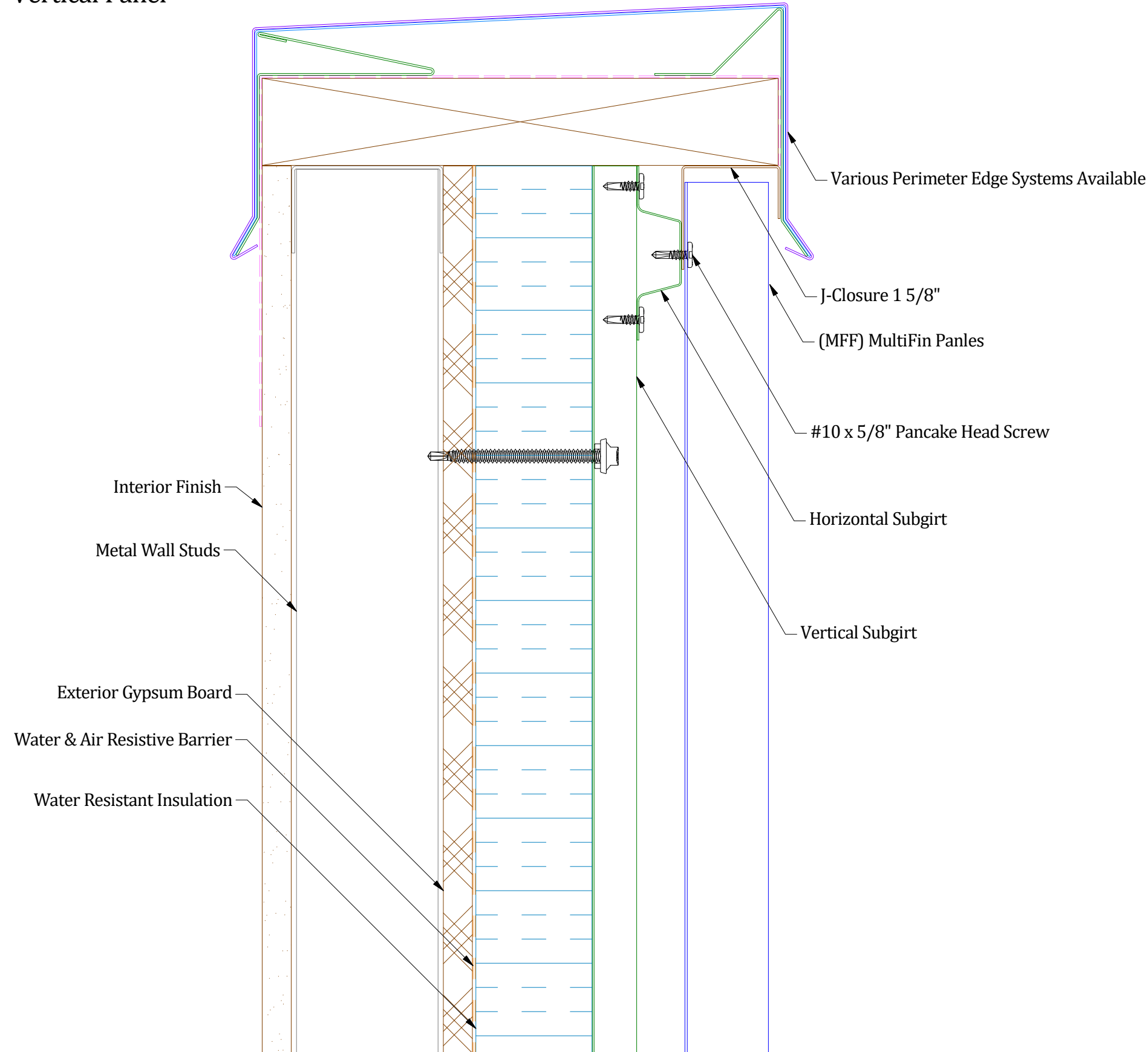

J-Closure

**Notes:**  
1) \* denotes color side.

**ATAS International, Inc.**  
Sustainable Solutions For A Better Future  
www.atas.com | info@atas.com  
800.468.1441

DWG TITLE: <b>Open Framing Top of Wall Detail</b>		DWG No.:		DWG BY: M.L.P.	DWG DATE: 5/1/2026
0	5/1/2026	Initial Release	M.L.P.	D.S.	APP BY: D.S.
REV. NO.	DATE	DESCRIPTION OF REVISION	BY	APP	PANELS/PRODUCT: <b>(MFF) MultiFin</b>
					APP DATE: 5/1/2026
					SHEET SIZE: B
					SCALE: X : X

# Vertical Panel

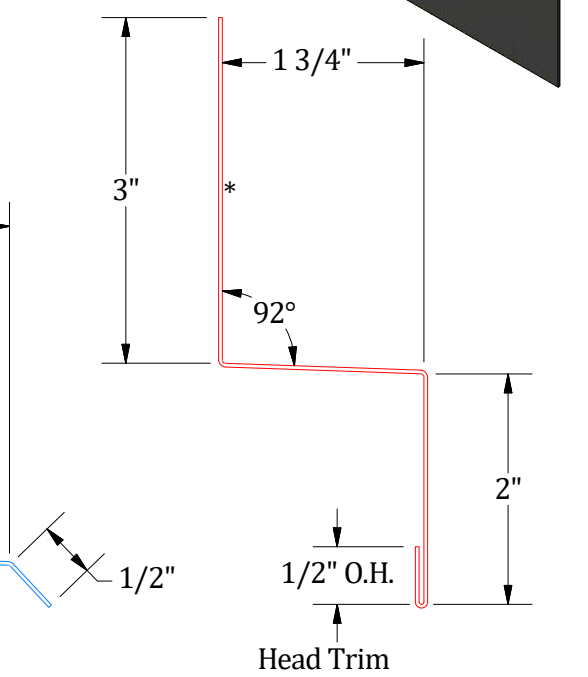
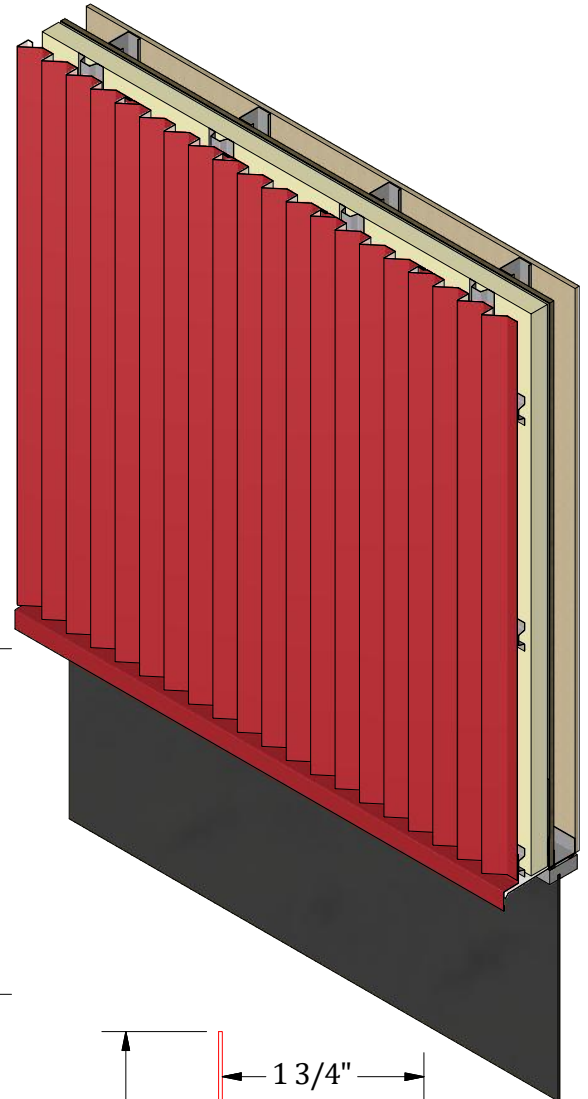
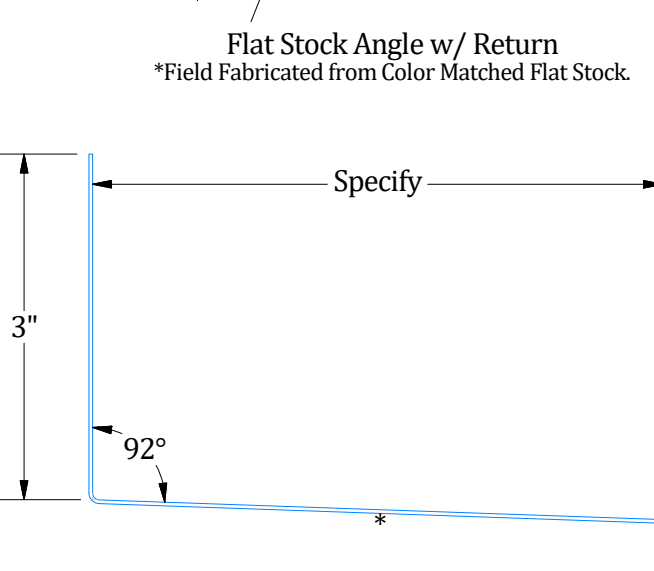
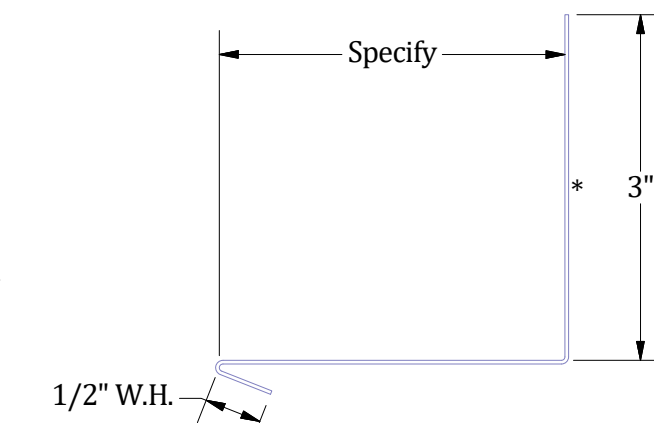
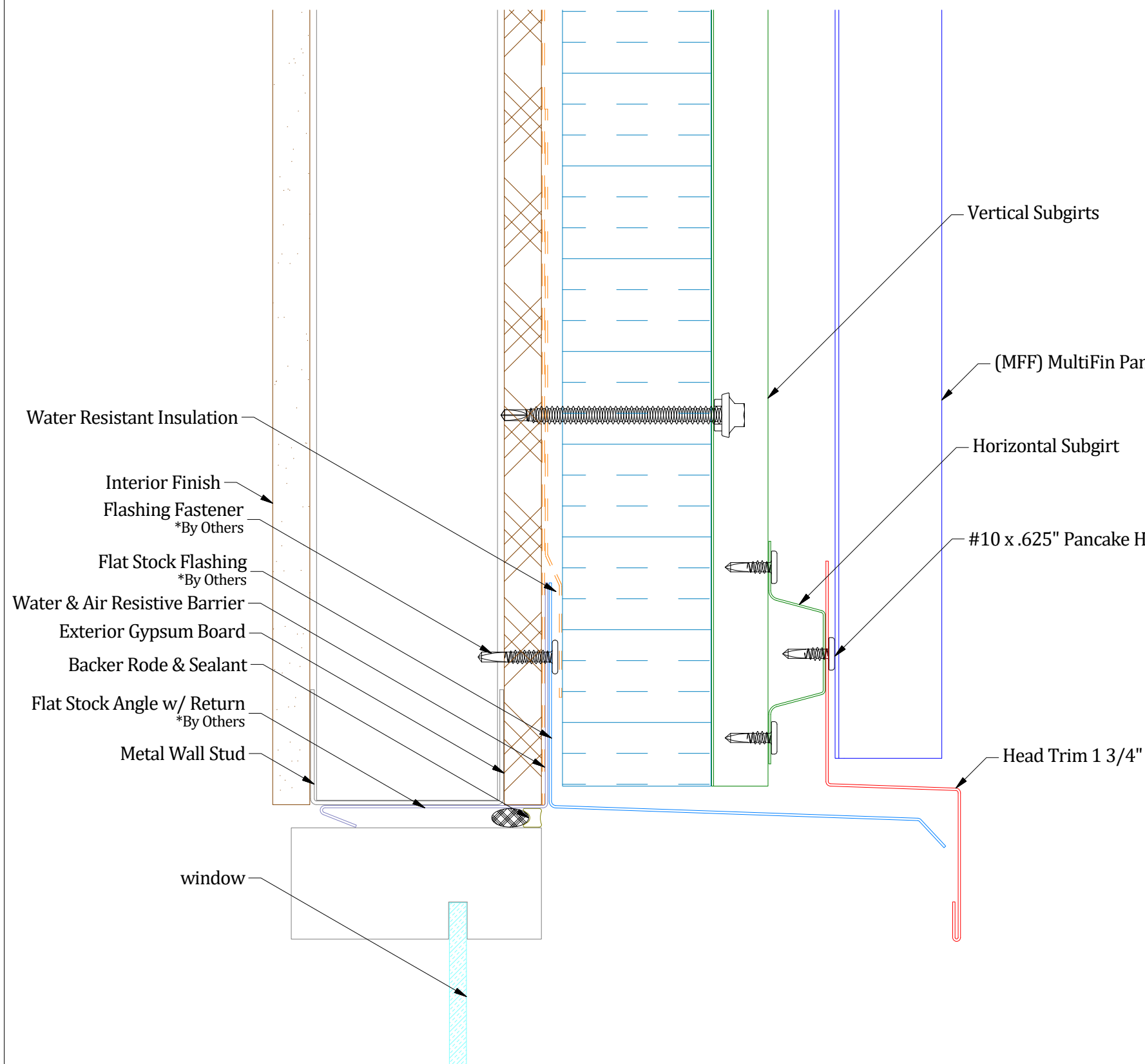

**Notes:**  
1) \* denotes color side.

**ATAS** **ATAS International, Inc.**  
Sustainable Solutions For A Better Future  
www.atas.com | info@atas.com  
800.468.1441

REV. NO.	DATE	DESCRIPTION OF REVISION	BY	APP	DWG TITLE:	DWG No:	DWG DATE:	APP BY:	APP DATE:	SHEET SIZE:	SCALE:
0	5/1/2026	Initial Release	M.L.P.	D.S.	Open Framing Window Head Detail		5/1/2026	D.S.	5/1/2026	B	X : X
					PANELS/PRODUCT:		(MFF) MultiFin				

# Vertical Panel

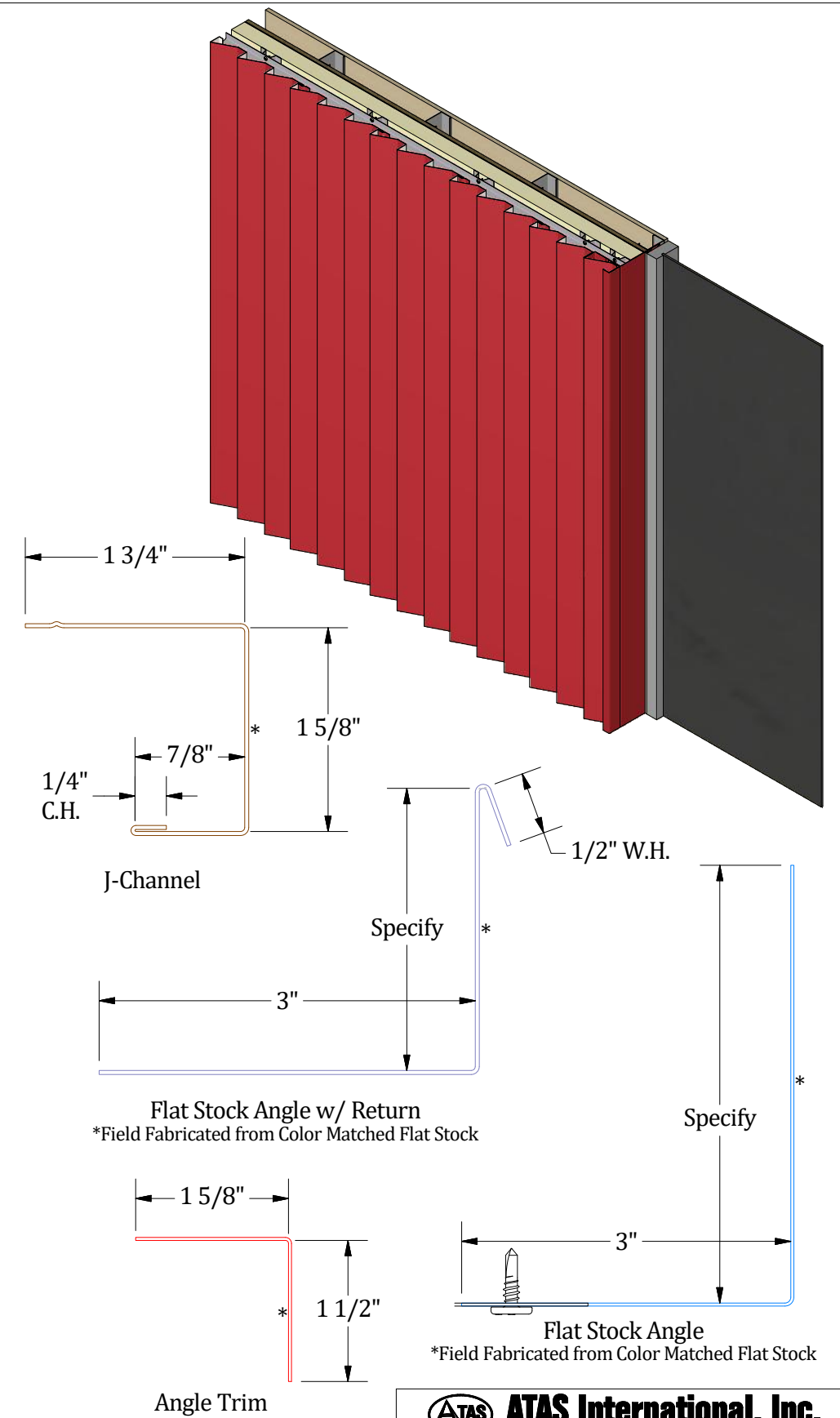
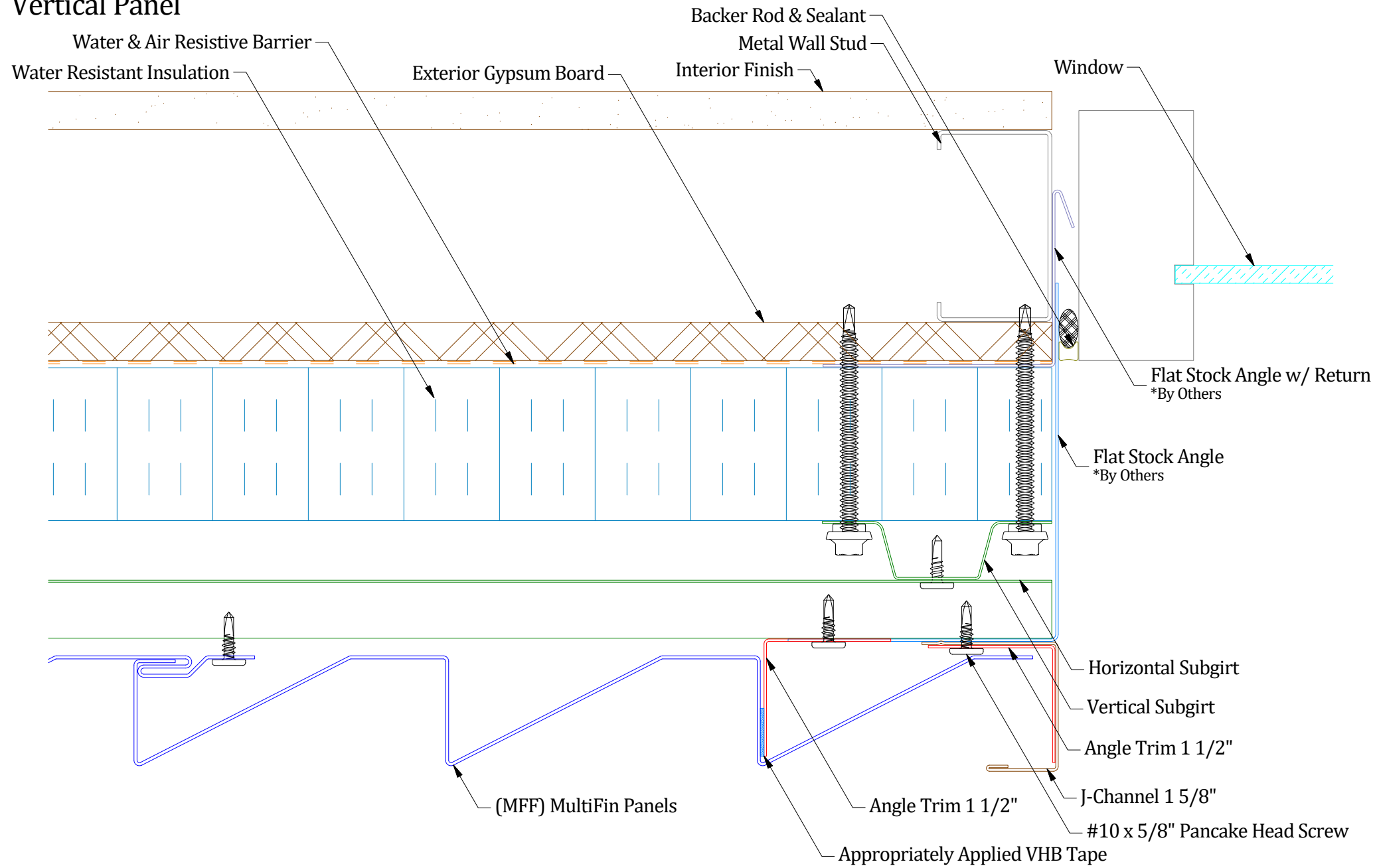

## Notes:

1) \* denotes color side.

**ATAS International, Inc.**  
 Sustainable Solutions For A Better Future  
 www.atas.com | info@atas.com  
 800.468.1441

REV. NO.		DATE	DESCRIPTION OF REVISION	BY	APP	DWG TITLE:	
0	5/1/2026	Initial Release		M.L.P.	D.S.	Open Framing Window Jamb Detail	
						DWG No.:	
						DWG BY: M.L.P.	
						APP BY: D.S.	
						DWG DATE: 5/1/2026	
						APP DATE: 5/1/2026	
						SHEET SIZE: B	
						SCALE: X : X	

PANELS/PRODUCT: (MFF) MultiFin

# Vertical Panel

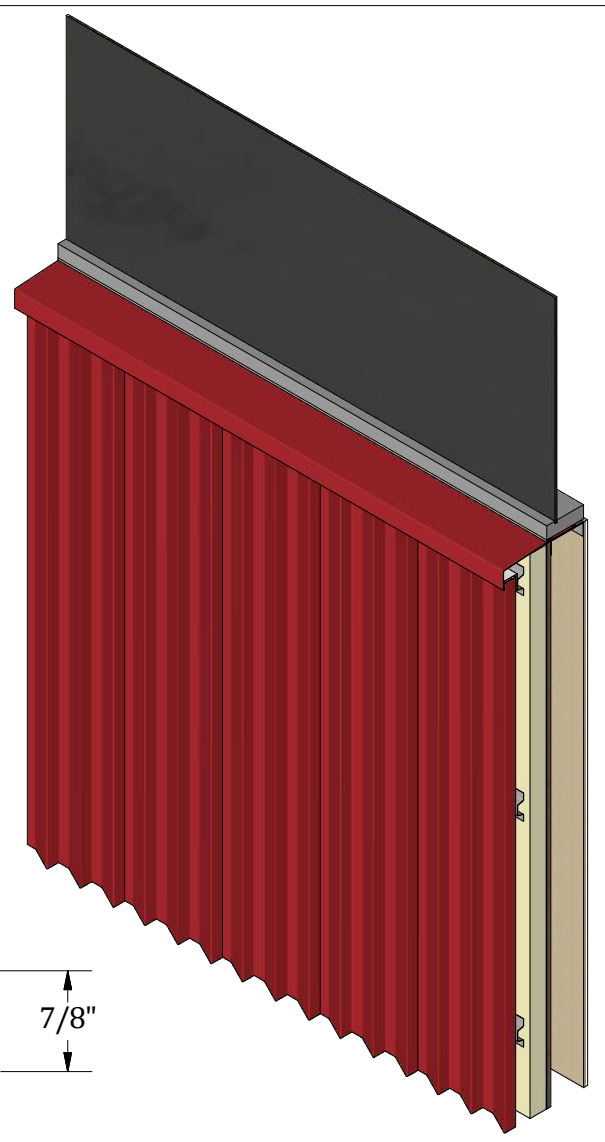
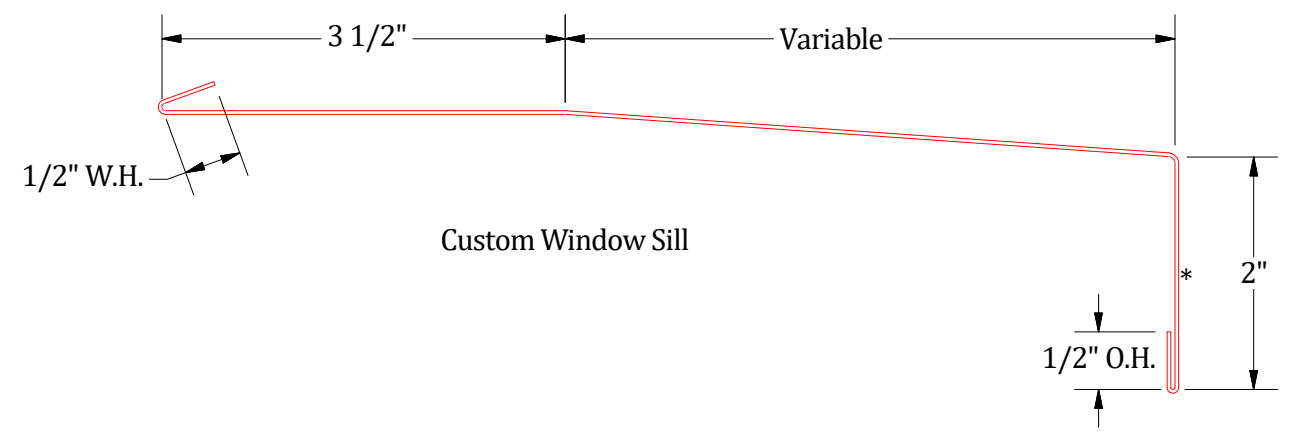
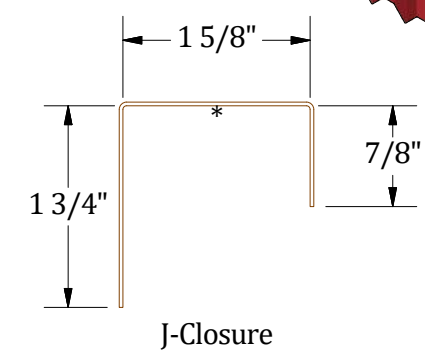
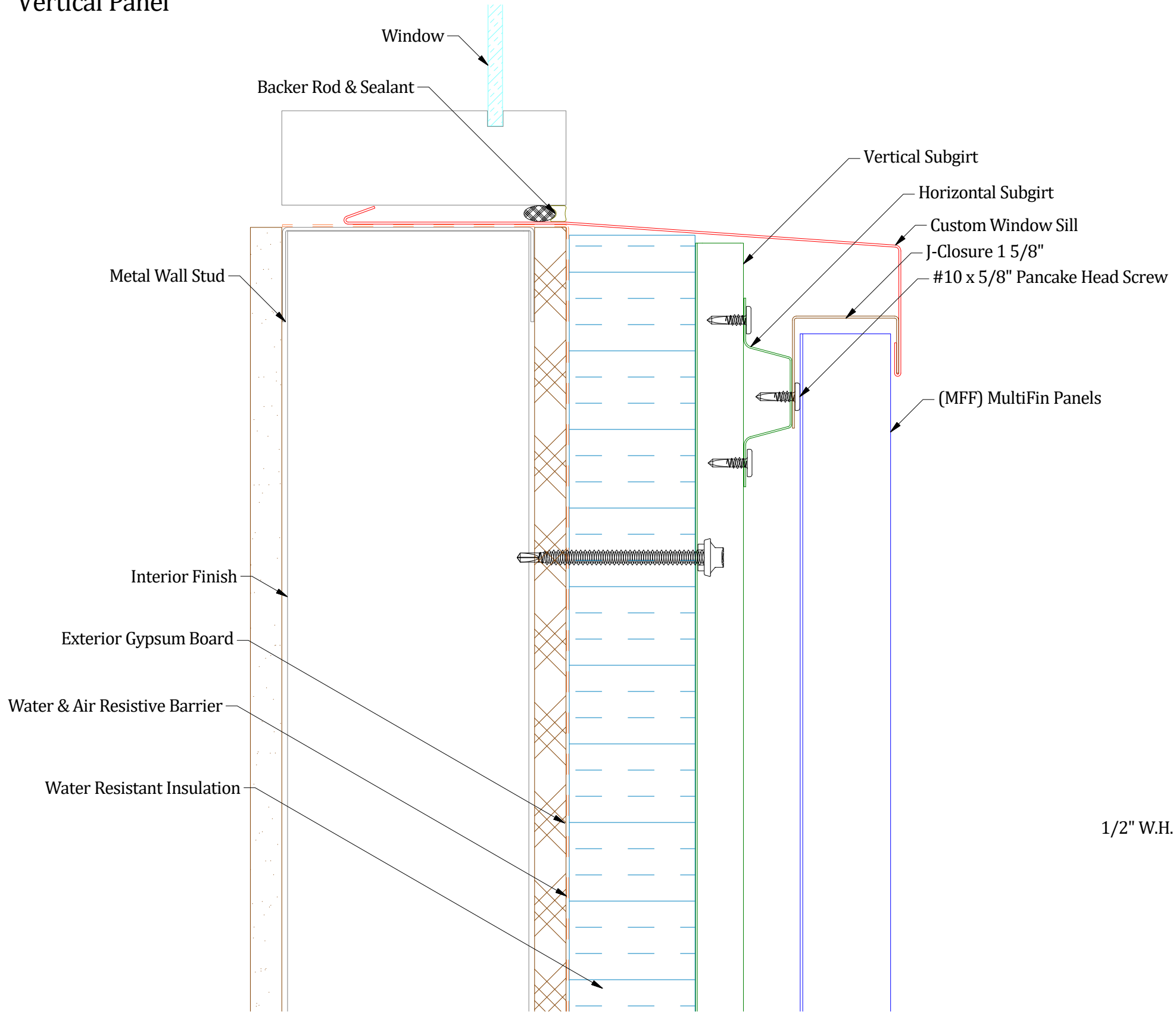

**Notes:**  
1) \* denotes color side.

**ATAS International, Inc.**  
Sustainable Solutions For A Better Future  
www.atas.com | info@atas.com  
800.468.1441

DWG TITLE: <b>Open Framing Window Sill Detail</b>		DWG No.:		DWG BY: M.L.P.	DWG DATE: 5/1/2026
0	5/1/2026	Initial Release	M.L.P.	D.S.	APP DATE: 5/1/2026
REV. NO.	DATE	DESCRIPTION OF REVISION	BY	APP	PANELS/PRODUCT: <b>(MFF) MultiFin</b>
					SHEET SIZE: B
					SCALE: X : X